



Vinyl Anaerobic Chamber Operation Manual

Coy Laboratory Products, Inc.

14500 Coy Drive
Grass Lake, Michigan 49240

(734) 475-2200
www.coylab.com

Copyright© 2013 by Coy Laboratory Products, Inc.

All rights reserved. Except as noted in the paragraph immediately following, no part of this publication may be reproduced, stored in a retrieval system, or transmitted in any form or by any means, electronic, mechanical, photocopying, recording, or otherwise, without the prior written permission of Coy Laboratory Products, Inc.

You may print two copies of the manual from the supplied electronic copy for internal use. These copies are subject to the restrictions given in the paragraph above. This permission is limited to printed copies only. You may not make additional copies of the electronic copy or copy the files to your computer. If more printed copies are needed, or if you need to make electronic copies, you must get written permission from Coy Laboratory Products, Inc.

The information in this manual is subject to change without notice and should not be construed as a commitment by Coy Laboratory Products, Inc. While every effort has been made to ensure the accuracy of the material, Coy Laboratory Products, Inc., assumes no responsibility or liability for any errors, inaccuracies or omissions that may be present in this manual.

Document History

Part #	Manual Version	Product Version	Date
1200001	Vinyl Anaerobic Chamber Operation Manual 090113	Vinyl Anaerobic Chambers 2006 to present	Sept. 1, 2013

Safety, Warranty, and Support Information

WARNING!

DO NOT USE PURE HYDROGEN IN ESTABLISHING AND MAINTAINING YOUR CHAMBER ENVIRONMENT. USE ONLY PRE-MIXED GASES. THE USE OF PURE HYDROGEN OR PRE-MIXED GASES WITH A HYDROGEN CONTENT GREATER THAN 4 % MAY CREATE AN EXPLOSIVE MIXTURE IN YOUR CHAMBER.

LATEX WARNING!

LATEX GLOVES WITH POWDER MAY BE INSTALLED ON THIS EQUIPMENT. SOME PEOPLE MAY BE ALLERGIC TO LATEX AND/OR THE POWDER. COY LABORATORY PRODUCTS CANNOT ACCOUNT FOR THE CONTENT OF GLOVES BOUGHT FROM OTHER VENDORS.

WARRANTY

The electronic components in this chamber are warranted against defects in material and workmanship during the first 12 months after original date of shipment. Vacuum pumps that have been damaged due to rusting or moisture will not be covered under this warranty.

The vinyl bag portion of the anaerobic chamber is warranted against defects in material and workmanship for a period of 1 year after original date of shipment.

The factory will, at its option, either repair or replace defective materials within the above periods at no charge for parts and labor.

All returns or exchanges must first be authorized by Coy Laboratory Products, Inc.

14500 Coy Drive
Grass Lake, Michigan 49240

Phone: 734-475-2200
Fax: 734-475-1846

THE RESPONSIBILITY OF COY LABORATORY PRODUCTS, INC., IS LIMITED TO THE PURCHASE PRICE OF THIS PRODUCT. COY LABORATORY PRODUCTS, INC., WILL NOT BE RESPONSIBLE FOR ANY CONSEQUENTIAL DAMAGES.

THIS WARRANTY DOES NOT COVER DAMAGE IN SHIPMENT OR DAMAGE AS A RESULT OF IMPROPER USE OR MAINTENANCE OF THE PRODUCT.

THIS WARRANTY DOES NOT COVER DAMAGES CAUSED BY EXCESSIVE LINE TRANSIENTS ON THE AC SUPPLY LINE.

TECHNICAL SUPPORT

To obtain technical support, contact Coy Laboratory Products by either phone or e-mail:

Phone: (734) 475-2200

E-mail: techservice@coylab.com



Contents

Document History	ii
Safety, Warranty, and Support Information	iii
1 Introduction to the Vinyl Anaerobic Chamber.....	1
1.1 Chamber Models	1
1.2 Standard Components	3
1.3 How the Chamber Works	7
2 Optional Components.....	11
2.1 Interior Shelves	11
2.2 Model 12 Anaerobic Monitor (CAM 12)	12
2.3 Model 2000 Incubator	12
2.4 Desiccant Stak-Paks	12
2.5 Incandescent Flaming Device (IFD)	13
2.6 Gas Injection System	13
2.7 Recirculating Atmosphere Filter	14
2.8 Gas Leak Detector	14
2.9 Large Capacity Dehumidifier	15
2.10 Hydrogen Sulfide Removal Column	15
3 The Automatic Airlock.....	17
3.1 The Airlock Doors	18
3.2 Airlock Control	19
3.3 The Vacuum Pump Connections	20
3.4 Gas Line Connections	20
3.5 Replacing the Copper Tubing	24
3.6 Changing Gas Supply Tanks	25
3.7 Diagnosing Gas Line Leaks	28
4 Operating the Automatic Airlock Controller.....	29
4.1 Controller Basics	29
4.2 Changing Configuration Settings	31
4.3 Setting Up Profiles	35
4.4 Running the Airlock in Automatic Mode	39
4.5 Operating the Airlock in Manual Mode	42
4.6 Operating with the Manual Control Switches	43

5	Catalyst Fan Box Operation	45
5.1	Catalyst Fan Box Features	45
5.2	How the Fan Box Works	46
5.3	Positioning Catalyst Fan Boxes in the Chamber	47
5.4	Catalyst Stak-Paks	48
5.5	The Heated Fan Box Controller	51
5.6	Calibrating the Controller	53
5.7	Replacing the Heating Cones	55
6	Controlling the Chamber Atmosphere	59
6.1	Maintaining an Anaerobic Environment	59
6.2	Controlling Moisture	61
6.3	Hydrogen Sulfide Control	66
7	Chamber Care and Maintenance	69
7.1	Precautions	69
7.2	Preventive Maintenance Schedule	69
7.3	Cleaning the Vinyl	70
7.4	Detecting Chamber Leaks	70
7.5	Greasing the Airlock Door Handle Push Pins	72
7.6	Cleaning the Airlock Door Seal	73
7.7	Checking the Airlock Door Seal for Leaks	74
7.8	Draining the Vacuum Pump Moisture Trap	76
7.9	Making Minor Repairs	76
	Parts List	83

1 Introduction to the Vinyl Anaerobic Chamber



The Coy vinyl anaerobic chamber is constructed of flexible PVC vinyl. The seams are sealed together using a radio frequency welding technique. The bottom of the chamber is attached to a ¾-inch plywood base, which is padded with foam and covered with vinyl. The chamber is supported by a tubular aluminum frame, which is also attached to the plywood base.

The chamber is a totally sealed unit, except for two entry ports: the equipment entry port and the airlock:

- The equipment entry port is used for installing large equipment during setup. It is sealed with a large plastic disk, which is held in place with vinyl tape, prior to purging oxygen from the chamber and establishing the anaerobic environment.
- The airlock is used on a regular basis by lab personnel to pass items between the chamber and the outside environment without disrupting the chamber's anaerobic environment.

Lab personnel access the chamber to perform their operations through glove ports, which have permanently attached sleeves and replaceable latex or neoprene gloves. The gloves are attached to a special cuff, which is placed in the sleeve and taped in place, forming an airtight connection.

1.1 Chamber Models

The standard chamber comes in three sizes:

Type A:



Chamber Size	Base Size	Glove Ports
32 in % 59 in (81.3 cm % 149.9 cm)	36 in % 77 in (91.4 cm % 195.6 cm)	2

Type B:



Chamber Size	Base Size	Glove Ports
32 in % 78 in (81.3 cm % 198.1 cm)	36 in % 95 in (91.4 cm % 195.6 cm)	4

Type C:



Chamber Size	Base Size	Glove Ports
32 in % 42 in (81.3 cm % 196.7 cm)	36 in % 60 in (91.4 cm % 152.4 cm)	2

Custom configurations are also available. The information and instructions in this manual apply to custom configurations as well as the standard types.

The chamber and the frame supports are attached to the chamber base at the factory. The aluminum frame is shipped dismantled and must be assembled during setup. A large plastic disk is provided to seal the equipment entry port after the components have been installed.

1.2 Standard Components

The standard chamber package includes the following components:

Component	Type A	Type B	Type C
Airlock	1	1	1
Vacuum Pump	1	1	1
Gas Pressure Regulator (Background Gas)*	1	1	1
Gas Pressure Regulator (Gas Mix)*	1	1	1
Copper Tubing (5 ft section)*	2	2	2
Catalyst Fan Boxes	2	2	1
Catalyst Stak-Paks	4	4	2
Power Strip	1	1	1
Feed-Thru Adapters with Rubber Stoppers	2	2	2
Gloves	1 pair	2 pair	1 pair
Work Mats	1	2	1
Chamber Setup and Care Kit	1	1	1

*Gas regulators and copper tubing are not included with many non-US orders, in which case they may either be supplied by local dealers or left to the customer to provide.

1.2.1 The airlock

The airlock is used for the transfer of items from the lab environment to the anaerobic chamber and vice versa. It has two doors. The inner door seals the airlock from the chamber, and the outer door seals the airlock from the external environment.

Your chamber has an automatic airlock:



Automatic airlocks are operated through a controller that can be programmed to automatically perform the vacuum and purge procedures used during day-to-day operations before transferring materials into or out of the chamber. The airlock can also be operated manually through the controller. Manual switches are provided to operate the airlock in case of controller failure.

1.2.2 The vacuum pump

The vacuum pump is used to remove existing gases from the chamber or the airlock during vacuum and purge operations:



A flexible hose clamps onto a connecting tube on the airlock and a corresponding connector on the vacuum pump.

The vacuum pump is electrically connected to the automatic airlock and is operated through the airlock controller, either in automatic or manual mode.

1.2.3 The gas pressure regulators

Two gas pressure regulators are provided to control the pressure of the gases flowing into the airlock—one for the background gas (usually nitrogen) and one for the hydrogen gas mix:



Background Gas Pressure Regulator



Gas Mix Pressure Regulator

The two regulators are fundamentally the same, except for the fittings that connect to the supply tank valve.

The pressure regulators connect directly to the tank valve of the supply tank. Copper tubing is provided to connect the pressure regulators to the airlock:



Note: Some non-US/Canadian installations are not supplied with the pressure regulators or copper tubing described above.

1.2.4 Catalyst fan boxes

Catalyst fan boxes circulate the chamber's atmosphere through palladium catalyst, which, in the presence of hydrogen, removes oxygen. They also provide a homogeneous mix of gases in the chamber.

Catalyst boxes may be either heated or unheated:



Heated Catalyst Box



Unheated Catalyst Box

1.2.4-A The heated catalyst fan box

The standard heated catalyst fan box can maintain the chamber's temperature from ambient to about 40 °C. A high-range version can maintain temperatures to 50 °C. The desired temperature is set through a controller, which automatically turns the heat on and off as needed to maintain the temperature. The fan operates continuously to circulate the chamber's atmosphere, regardless of whether the heat is on or off.

1.2.4-B The unheated catalyst fan box

The unheated catalyst fan box is used for chambers that do not need temperature control or that have a separate incubator inside the chamber. When the unheated catalyst fan box is plugged in, the fan turns on immediately and runs continuously to circulate the chamber's atmosphere.

1.2.5 Catalyst Stak-Paks

A Stak-Pak is a wire mesh container that can be placed in the Stak-Pak holder in the front of the catalyst fan box:

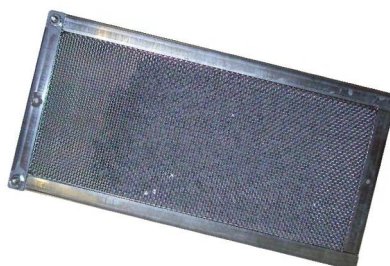

The catalyst Stak-Pak contains alumina pellets coated with a thin layer of palladium chloride. The palladium chloride causes hydrogen and oxygen molecules to form water molecules, which removes the oxygen from the chamber. The water is absorbed by the alumina.

1.2.6 Feed-thru adapters

Feed-thru adapters provide airtight entry points for outside connections (e.g., power cords, tubing, and computer cables), that need to be passed through the wall of the sealed chamber. Two feed-thru adapters are provided with standard chambers. The larger one is for the power strip (see section 1.2.7). The other can be used as needed:



The stopper for the feed-thru adapter is installed on the power cord of the power strip at the factory. It can be repositioned on the cord as needed for the placement of the strip. A stopper is provided for the other adapter. It can be adapted to fit a power cable or other connection. Instructions for adapting the stopper to a cable can be found in the feed-thru adapter manual.



Note: Your chamber may have additional feed-thru adapters installed if they were requested when the chamber was purchased. They cannot be added aftermarket to existing chambers.

1.2.7 Power strip

A 6-receptacle power strip is included to provide power to the components installed in the chamber:



It is inserted into the chamber through one of the feed-thru adapters (see section 1.2.6). For non-US installations, the power strip is often pre-installed and will look different than the picture above. In some cases, the power strip is customer provided.

1.2.8 Gloves

One pair of gloves is installed prior to shipping for each set of glove ports:



Unless otherwise requested when the order was made, latex gloves will be installed. If your company requested it, neoprene gloves may be installed instead. The gloves will be a size “Large” unless a different size was requested when the order was placed.

One spare pair of gloves (latex, size “Large”) is included in your chamber setup and care kit (see section 1.2.9). Additional gloves of either material in your choice of size may be purchased from Coy.



Caution: *If you are latex sensitive, do not put your hands in the gloves until you have verified that they are neoprene and not latex. If they are latex, you will not be able to use the chamber until you replace them with neoprene gloves.*

1.2.9 Chamber setup and care kit

The chamber setup and care kit includes items that are needed for the setup and maintenance of your chamber:



It includes the following:

- One roll of 3M™ yellow vinyl tape
- One replacement cuff for glove replacement
- One pair of replacement gloves
- One 1/32-inch allen wrench
- One 1/8-inch allen wrench
- One tube of liquid vinyl repair
- Extra vinyl for leak repair



Note: *The yellow vinyl tape is used for sealing the equipment entry port and also for glove replacement. 3M yellow vinyl tape is the only tape Coy has found that leaves no sticky residue and is airtight.*

1.3 How the Chamber Works

The chamber is completely sealed from the laboratory environment. The only entrance to the chamber is through the airlock. The chamber’s anaerobic environment is a hydrogen gas mix, which is continuously circulated through the chamber by the catalyst fan boxes. As long as sufficient hydrogen is present, any oxygen that is drawn into the catalyst fan boxes is removed when it comes into contact with the palladium catalyst.

1.3.1 The anaerobic environment

Two gases are used to create the anaerobic environment—a background gas (aka purge gas) and a hydrogen gas mix. The gases are customer-provided. Coy does not supply the gases.

To establish the initial anaerobic environment, the oxygen-rich air is removed and the chamber is filled with background gas. After the oxygen is purged from the chamber, the chamber is filled with the hydrogen gas mix. This procedure is described in detail in the *Vinyl Anaerobic Chamber Setup Manual*.

The above process is repeated until the amount of hydrogen, which must be present for ongoing oxygen removal, is sufficient. Any remaining oxygen is removed when the chamber atmosphere is circulated through the catalyst fan boxes and passes through the palladium catalyst. Periodically, the chamber hydrogen content must be refreshed to ensure that there is enough hydrogen for oxygen removal.

1.3.2 The gases

Any inert gas can be used as a background gas. The most commonly used background gas is nitrogen, which is both safe and inexpensive. The gas mix should be no more than 4 % hydrogen, with the balance being any inert gas. It is OK to use standard or inexpensive mixes of hydrogen and inert gas. You do not need to purchase specialty gases, as they are expensive. Check with your gas supplier regarding quality options.

4 % hydrogen is non-flammable but still provides enough hydrogen for oxygen removal. Mixes with lower levels are acceptable but the chamber's hydrogen content may need to be refreshed more frequently. Flammable gas mixes should not be used.

1.3.3 Daily operation

Although the anaerobic chamber is technically airtight, small amounts of oxygen may still enter the chamber through the airlock or by diffusion, primarily through the gloves. It is removed by the palladium catalyst when the chamber atmosphere (hydrogen gas mix) is circulated through the catalyst fan boxes. The outer airlock door is kept closed to seal the chamber from the external environment:

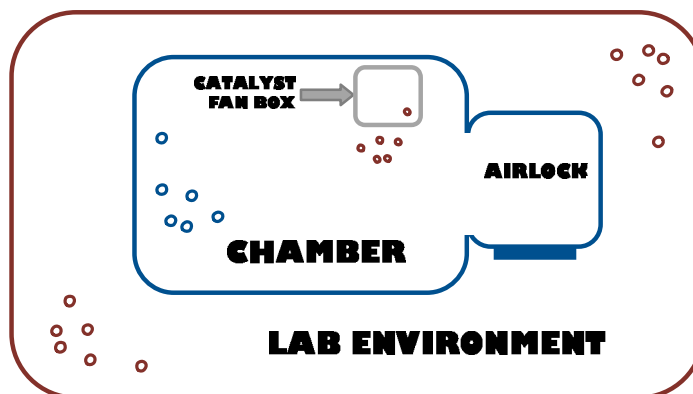

To maintain anaerobic conditions during daily operations, all lab materials and equipment that enter the chamber must enter through the airlock. The inner door of the airlock is closed to seal the chamber prior to opening the outer door. When the airlock's outer door is opened, air containing oxygen enters the airlock from the external environment:

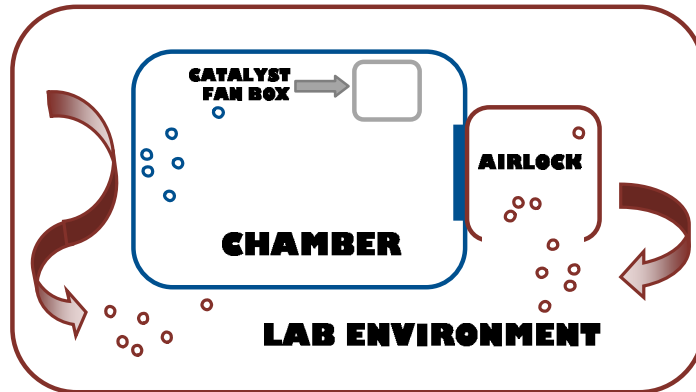

After the material to be entered into the chamber is placed in the airlock, the airlock's outer door is shut. The airlock is vacuumed and backfilled with background gas to remove the oxygen. Then it is vacuumed again and filled with the hydrogen gas mix:

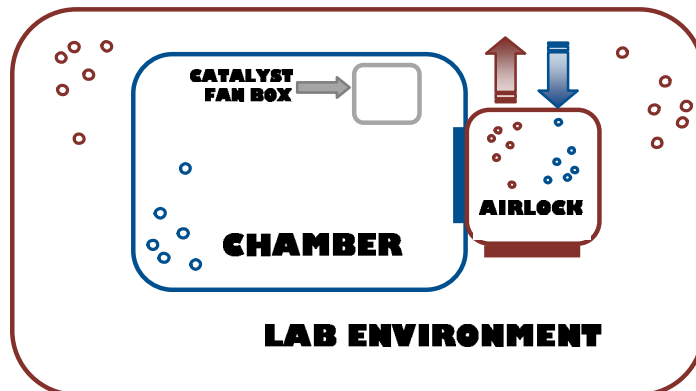

The inner door is opened so the material can be retrieved and taken into the chamber. The hydrogen gas mix from the airlock mixes with the hydrogen gas mix from the chamber, replenishing the hydrogen supply. Any remaining oxygen entering from the airlock is removed by the catalyst:

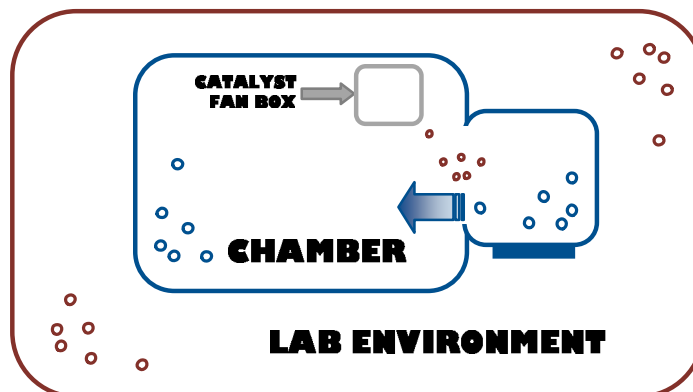

10 Vinyl Anaerobic Chamber Operation Manual

Items to be removed from the chamber also pass through the airlock. If the airlock is anaerobic, the items are simply placed in the airlock and the inner door is closed to seal the chamber. Then the outer door can be open to remove the items. If the airlock is aerobic, anaerobic conditions must be restored before the transfer can take place.

2 Optional Components

2

A number of optional components are available for vinyl anaerobic chambers. Your lab may have purchased one or more of them. In this chapter, we give you an overview of each of them. The anaerobic monitor, shelving, and incubator are the most commonly purchased optional components.



Note: Each component comes with a manual, which contains complete instructions for setup and operation, so we do not provide this information in this manual. However, we may give instructions for using some of these components in conjunction with chamber operations in later chapters.

2.1 Interior Shelves

Most installations include a shelving unit. The 4-shelf units available for vinyl anaerobic chambers are 10.5 in (26.7 cm) deep and are available in 36 in (91.4 cm) and 28 in (71.1 cm) widths:



36 In (91.4 cm)



28 In (71.1 cm)

A 16 in (40.6 cm) 3-shelf unit is also available:



16 In (40.6 cm)

2.2 Model 12 Anaerobic Monitor (CAM 12)

The Model 12 Coy anaerobic monitor (CAM 12) is designed to monitor the oxygen/hydrogen content inside an anaerobic chamber:



This device takes the guesswork out of maintaining an anaerobic environment with sufficient hydrogen. It has two separate alarms, one for oxygen and one for hydrogen. The oxygen alarm can be adjusted to the level you want to consider high. Both an upper and a lower limit (between 1 % and 4 %) can be set for the hydrogen alarm.

2.3 Model 2000 Incubator

The model 2000 incubator is designed specifically for use in small spaces, so it is ideally suited to the chamber:



Because it has sliding doors, no space needs to be allowed for door opening. The standard unit has a temperature range of up to 40 °C. The high-range unit has a temperature range of up to 65 °C.

2.4 Desiccant Stak-Paks

Desiccant Stak-Paks are used to control moisture in the chamber:



They are attached to the catalyst Stak-Paks and the combined unit is placed in the Stak-Pak holder:



The desiccant Stak-Pak that is available through Coy contains alumina pellets. Empty Stak-Paks that can be filled with your own choice of desiccant are also available.

2.5 Incandescent Flaming Device (IFD)

The incandescent flaming device makes it easy to flame a bacteria loop or the edge of a culture tube:



It is operated with a foot switch that is installed outside of the chamber. The foot-switch cable is routed into the chamber through a feed-thru adapter. The stopper for the feed-through adapter is installed on the foot-switch cord.

2.6 Gas Injection System

The automatic gas injection system is designed to maintain a constant level of hydrogen gas mix in your chamber, ensuring that there is always enough hydro-

gen present to maintain an anaerobic environment. It injects the hydrogen gas mix into your chamber for a fixed time period on a fixed time schedule. The controller (pictured below) automatically controls the time and frequency of the gas flow:



Three timers, which can be adjusted to suit the needs of your chamber, control how often and for how long the gas mix is injected in your system.

The controller sits outside the chamber and is attached to a T-fitting on the gas pressure regulator, which allows both the gas injection system and the airlock to be connected to the gas mix tank.

2.7 Recirculating Atmosphere Filter

The atmosphere filter removes contamination from the chamber atmosphere:



The internal atmosphere is drawn out of the chamber by the vacuum pump on the unit, circulated through the filter, and returned to the chamber. It can remove contaminant particles 0.3 μm or larger. It cycles from 8.5 cm^3/h to 17.0 cm^3/h (30 f^3/h to 60 f^3/h) and can be run periodically on an as-needed basis.

2.8 Gas Leak Detector

The gas leak detector is used for detecting leaks in the anaerobic chamber:



It senses hydrocarbons (hydrogen gas mix) and will detect leaks as small as a pin hole. Because it detects hydrogen, it can also be used to detect leaks in the gas mix tubing and fittings. If you did not purchase this option, it is highly recommended that you do so, unless you already have a similar device.

2.9 Large Capacity Dehumidifier

The large capacity dehumidifier controls the moisture levels inside the Coy vinyl anaerobic chamber automatically without the use of desiccant:



It is a much better solution to serious moisture problems than using desiccant Stak-Paks.

When it is installed, it attaches to the frame side support by the equipment entry port. The dehumidifier disk is used to seal the equipment entry port instead of the standard plastic disk.

2.10 Hydrogen Sulfide Removal Column

Some types of chamber activities may generate hydrogen sulfide (H_2S). H_2S attacks certain metals and can damage catalyst. It also accelerates the discoloring of the vinyl over time.

The Coy hydrogen sulfide removal column (HSRC) is an efficient, effective method of controlling H_2S in your chamber:



The 28 in tall unit can be placed vertically on the floor of the chamber or horizontally in a special cradle on a 28 in or 36 in shelf:



Once installed, the HSRC provides maintenance-free, high-capacity removal of H₂S by continuously recirculating the chamber's atmosphere through the column.

The HSRC's unique layering of the removal media acts via a combination of adsorption and chemisorption and maintains performance under a broad range of operating conditions. An integrated airflow system, combined with the column design, ensures required contact time and flow rate to take advantage of the high H₂S removal capacity with single-pass H₂S clearance. No maintenance is required, except for changing the removal media every several months.

3 The Automatic Airlock

3

The automatic airlock is attached to the vinyl chamber and to the chamber base:



It has two entry points. The inner door, which is inside the chamber, seals the airlock from the chamber and the outer door seals the airlock from the external environment. One of these doors must be closed at all times to maintain the chamber's anaerobic environment. Whenever you open the outer door to transfer material, the inner door must be shut before the outer door can be opened. After the outer door has been opened, the airlock must be cycled to anaerobic conditions before the inner door can be opened again.

A control panel above the outer door is used to manually control the airlock and to program the airlock for automatic operation:

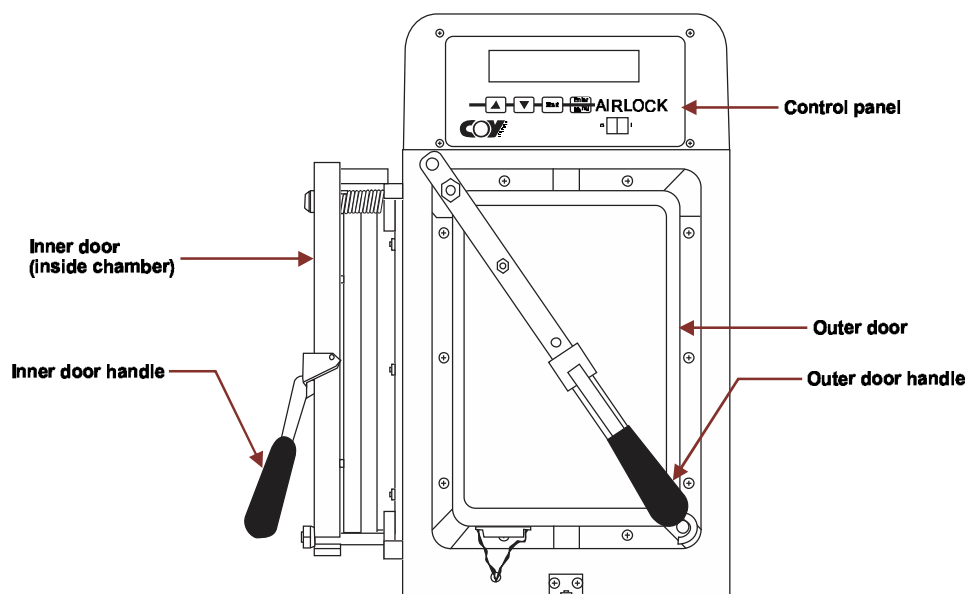

3.1 The Airlock Doors

The airlock doors have a spring-loaded corner pivot, which allows the doors to swing up and out of the way. In standard chambers and most custom chambers the outer door pivots up and to the right and the inner door pivots up and toward the back of the chamber.



Note: Some chambers may have the airlock on the opposite side. In that case, the outer door will open to the left. The inner door always opens toward the back of the chamber.

► **To open the door**

1. Pull the handle out to unlock the door.
2. Rotate the door upward:

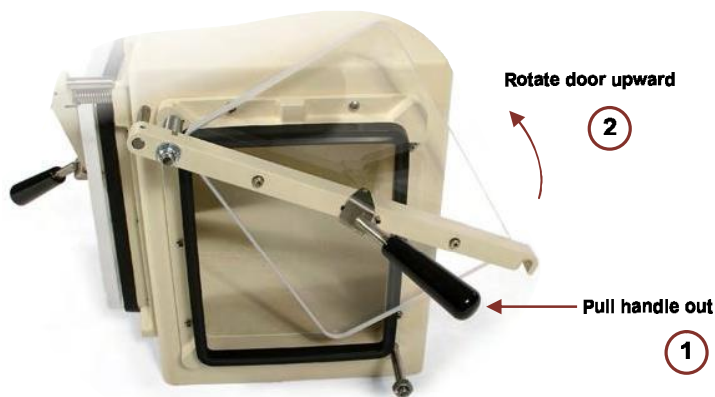

► **To close the door**

1. Holding the handle, rotate the door downward:

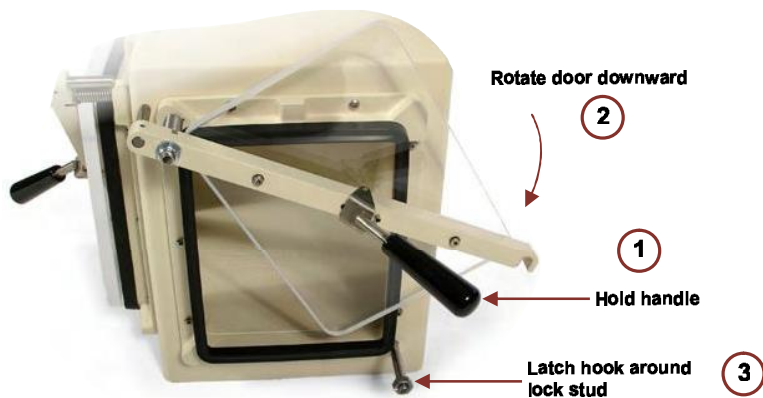

2. Make sure the hook latches around the lock stud (the pin at the bottom of the door opening):

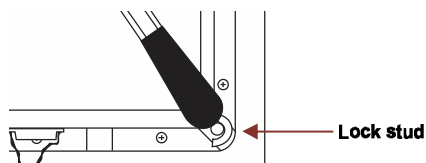

3. Push the handle in to lock it in place.

3.2 Airlock Control

The airlock controller controls the operation of the gases and the vacuum pump. The controller can be operated in either automatic mode or manual mode. The vacuum pump and the gas lines are connected to the airlock through the back panel. The airlock power cord plugs into a standard wall outlet.

3.2.1 The control panel

The control panel at the top of the airlock in the front is used to control the airlock directly when operating manually:



The control panel also allows you to set up and run stored routines to reestablish anaerobic conditions in your airlock when you transfer materials in and out of the chamber. Controller operation is discussed in Chapter 4.

3.2.2 The airlock connections

The back panel of the airlock contains the connections to the vacuum pump and gas lines. It also contains manual switches to operate the gas lines and vacuum pump in case of controller failure and the electrical connections:

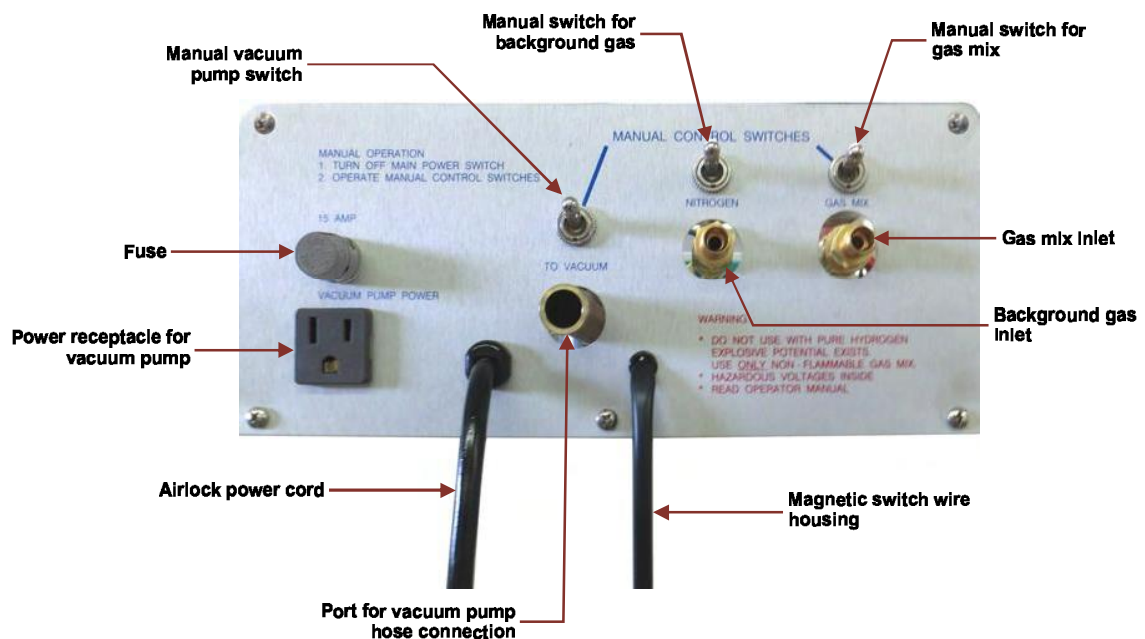

3.3 The Vacuum Pump Connections

The vacuum pump is connected to the airlock through the back panel and is operated from the airlock:

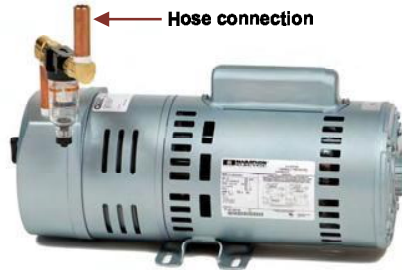

The vacuum pump power cable is plugged into the receptacle marked **VACUUM PUMP POWER** on the back of the airlock. The vacuum pump hose is connected to a connector tube on the pump and to the port marked **TO VACUUM PUMP** in the back panel of the airlock, which has a similar tube:

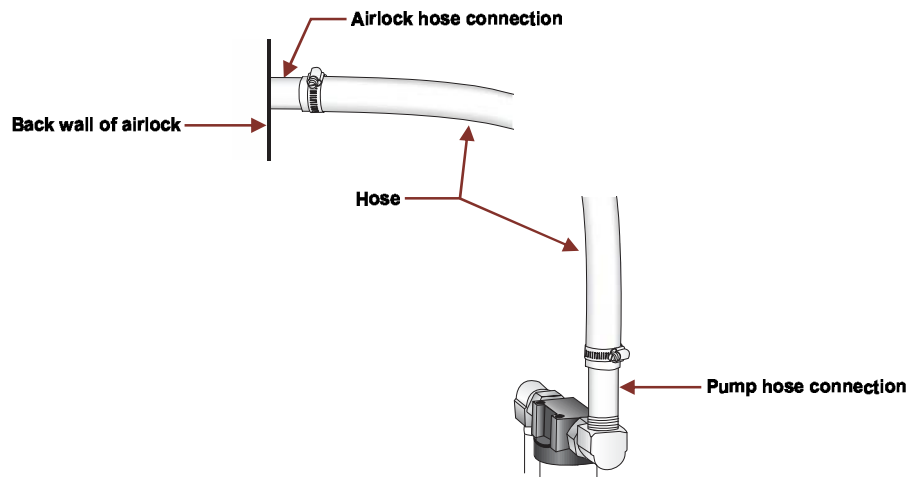

3.4 Gas Line Connections

The gas supply tanks are connected to the airlock through gas pressure regulators, which control the flow of gas from the tank to the airlock. There is one gas pressure regulator (labeled "Nitrogen") for the background gas tank and one (labeled "Gas Mix") for the gas mix tank. They are basically identical except for the fittings that connect to the supply tank:

Background gas pressure regulator:

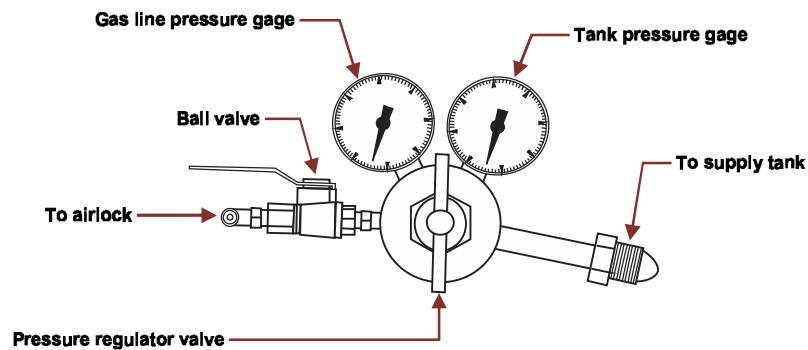

Gas mix pressure regulator:

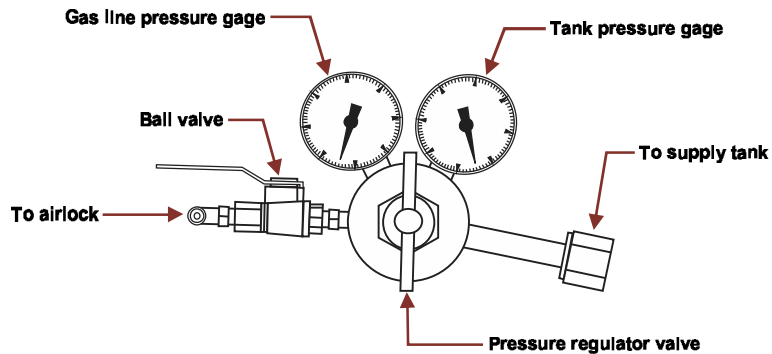

Note: The illustrations show a typical gas pressure regulator. Yours may look different if they were not Coy-supplied, but they should have the same parts and fittings.

The regulators are connected to the airlock with copper tubing (two 5 ft lengths are supplied for US/Canadian installations). Copper does not diffuse oxygen and is recommended for the strictest of atmospheres. Many non-US installations use vinyl tubing instead. Vinyl tubing does not kink and is easier to work with especially when changing gas tanks, but some oxygen diffusion may take place.

3.4.1 Gas quality

Coy anaerobic chambers can operate on low-quality gases, as the airlock and catalyst will remove any trace amounts of oxygen that enters the chamber with the gases. Calibrated and/or certified mixes dramatically increase cost and are often used to guarantee oxygen-free gas, but even low-grade gases contain very little oxygen and operate quite well with the chambers. Because the lower quality-control standards increase the possibility of supplier error, there is some risk of getting an oxygen-contaminated tank, although it happens very rarely. If you have a Coy anaerobic monitor or other digital monitor, you can see these contaminations the first time you operate the airlock with a contaminated tank.



Note: Paper or liquid indicators that change color in the presences of oxygen do not trigger at low enough levels to be an effective detector of contaminated tanks.

3.4.2 The background gas line

A length of copper tubing connects gas pressure regulator to the background gas inlet (labeled “Nitrogen”) on the back of the airlock. The pressure regulator attaches directly to the tank valve outlet. The fitting on the pressure regulator screws into the nut on the tank valve:

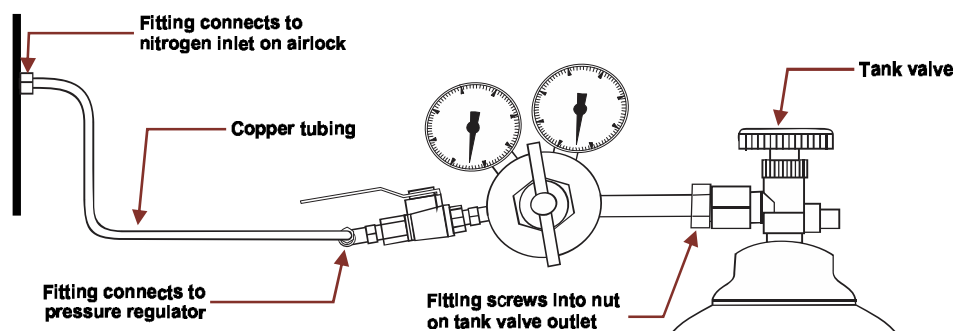

3.4.3 The gas mix line

Another length of copper tubing connects the gas mix pressure regulator to the gas mix inlet on the back of the airlock. The pressure regulator attaches directly to the tank valve outlet. The nut on the pressure regulator screws onto the fitting on the tank valve:

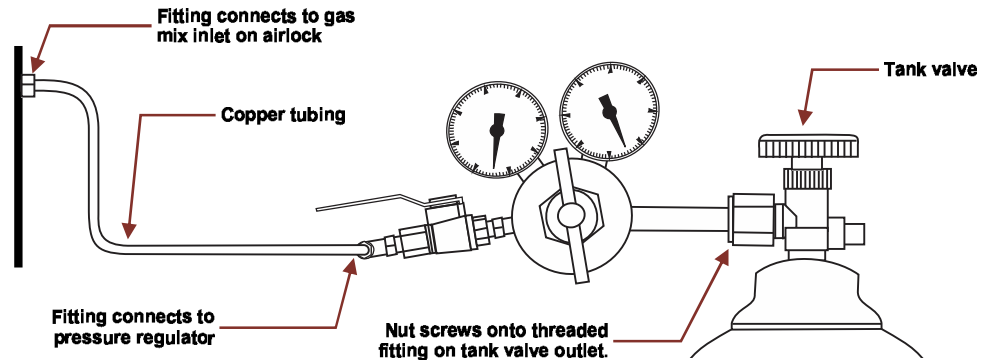

3.4.4 Controlling the gas supply

To supply the gas to the airlock, the gas must be turned on at the tank, and the ball valve on the pressure regulator must be open. You do not need to turn the gas on and off a daily basis. However, you may have to do so occasionally for maintenance purposes (diagnosing leaks, changing supply tanks, etc.).

We recommend 20 psi (138 kPa) of pressure for normal operating conditions, although in certain situations you may need to increase it. At higher pressure settings, the rapid influx of air into the airlock can knock over glassware, which, if it contains liquid and breaks, can cause major problems with the vacuum pump. Higher flow rates may also cause excess gas to flow past the door seals. Lower rates may be too slow for airlock operation, resulting in a “timeout” error.



Note: The 20 psi setting assumes the tank location is within 10 ft (3 m) of the airlock. For every additional 10 ft (3 m) of distance (measure the tubing length, not the tank-to-airlock distance) add 5 psi (34 kPa) to accommodate the pressure drop across this distance. For example, a tank 30 ft (9.1 m) from the airlock should operate at 40 psi (276 kPa). It should be noted that these are general numbers. Precise pressure is not necessary as conditions may vary. You may adjust as needed for your ideal lab conditions.

► To turn on the gas flow

1. Open the supply tank valve. The tank pressure gage will display the current pressure for the tank:

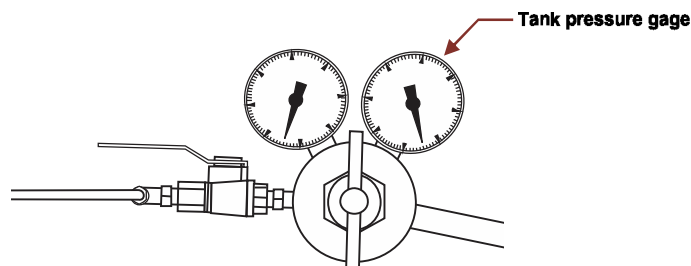

- Set the gas line pressure by turning the pressure regulator valve until the gas line pressure gage displays 20 psi (138 kPa):

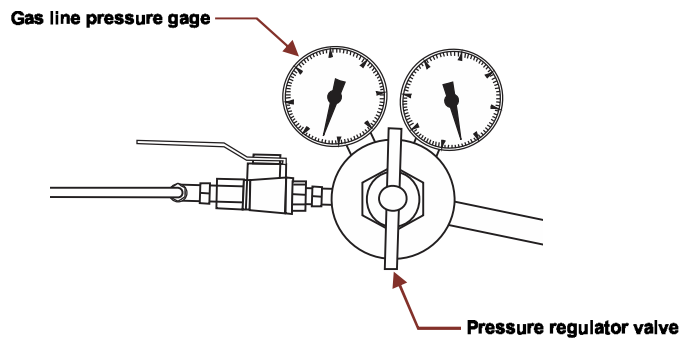

Turning the valve clockwise increases the pressure. Turning it counter-clockwise decreases it.



Important: Do not let the gas line pressure exceed 60 psi (414 kPa). Coy-supplied regulators only go to 60 psi (414 kPa), but regulators obtained from other sources may have a different upper limit.

- Open the ball valve by turning the ball valve lever parallel to the valve:

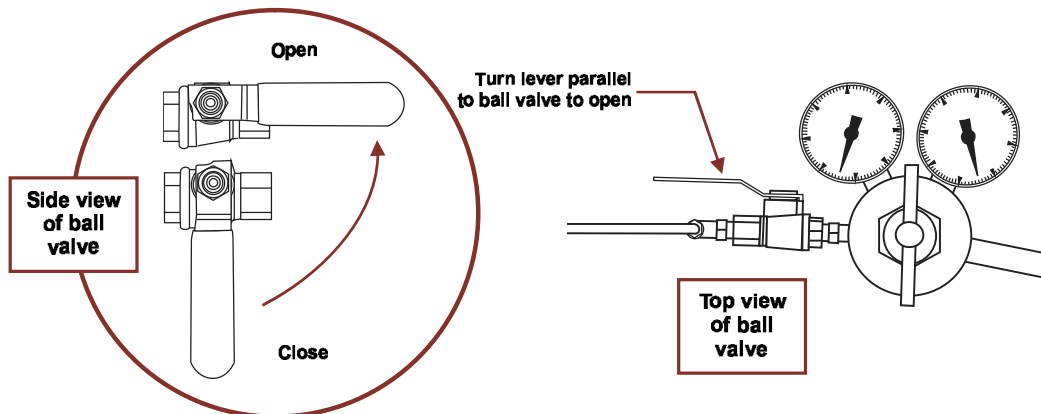

► To change the gas line pressure

- To increase gas line pressure, turn the pressure regulator valve counter-clockwise until the gas line pressure gage displays the desired pressure.
- To decrease gas line pressure, turn the valve clockwise until the gas line pressure gage displays the desired pressure.



Note: The change of pressure must be done when gas is flowing. If it is done while there is no pressure, the new adjusted pressure will not be displayed until the pressure is released.



Reminder: Do not let the airlock pressure exceed 60 psi (414 kPa).

► To turn off the gas flow

- Close the ball valve by turning the ball valve lever perpendicular to the valve.
- Turn the gas off at the supply tank.

3.5 Replacing the Copper Tubing

The copper tubing and fittings are, for the most part, trouble free. However, after extended use, they may become damaged and start to leak. If this happens, you will need to replace the copper tubing. The copper tubing supplied by Coy has a ferrule compression fitting on each end. The ends are identical.

► **To replace copper tubing**

1. Close the ball valve to the affected line.
2. Use a crescent wrench to loosen the fitting and remove the old copper tubing from the airlock inlet and the gas pressure regulator:

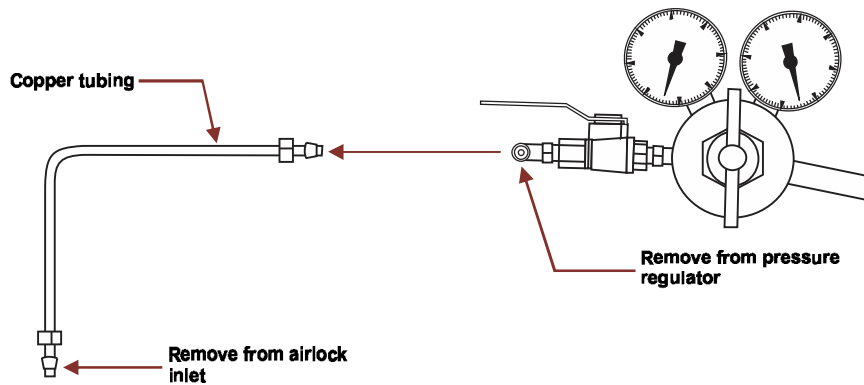

3. Insert the ferrule compression fitting on one end of the new copper tubing straight into the fitting on the pressure regulator:

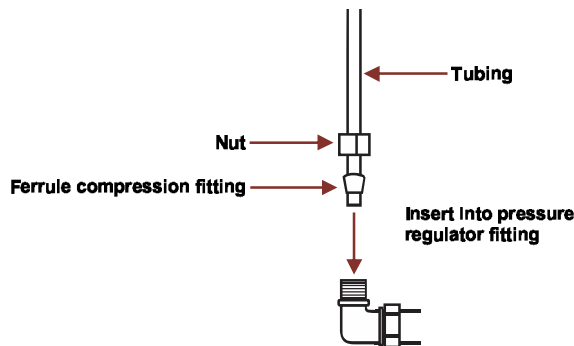

Important: The ferrule compression fitting *MUST* be inserted straight in to seal the connection. Do not go in at an angle, as a leak may result.

4. When the fitting is seated, slide the nut down to the threads on the pressure regulator fitting and finger-tighten the nut:



- Use a crescent wrench to tighten the nut further. Make sure it is snug. Do not overtighten.



Important: Overtightening a ferrule compression fitting can cause the ferrule to cut the copper tubing and produce a leak.

- Insert the ferrule compression fitting on the other end of the tubing straight into the appropriate inlet on the airlock back panel. Do not go in at an angle:

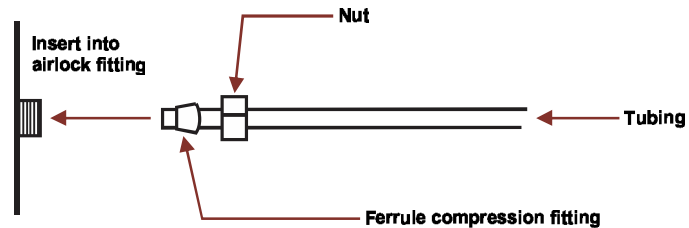

- When the fitting is seated, slide the nut down to the threads on the inlet fitting and finger-tighten the nut:

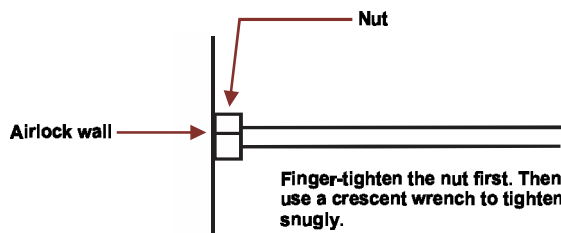

- Use a crescent wrench to tighten the nut further. Make sure it is snug. Do not overtighten.
- Open the gas line ball valve on the pressure regulator (section 3.4.4).
- Test the fittings for leaks (see section 3.7).



Important: When you route the copper tubing from the pressure regulator to the airlock, be careful not to kink the tubing, as kinking can cause leaks. Longer lines may require additional support.

3.6 Changing Gas Supply Tanks

When a supply tank is empty, you will need to replace it with a full one.



Important: The copper tubing does not support the pressure regulators. When you remove the pressure regulator from the supply tank, be sure to place it on a surface that will support it. If the regulators are left connected to the airlock during a tank change and are not fully supported, the fittings to the airlock can be damaged due to the excess weight.

► **To change background gas supply tanks**

1. If there is any gas in the tank (pressure is greater than 0), turn off the tank valve.
2. Close the gas line ball valve on the gas pressure regulator.
3. Use a crescent wrench to loosen the nut on the tank and remove the pressure regulator from the tank:

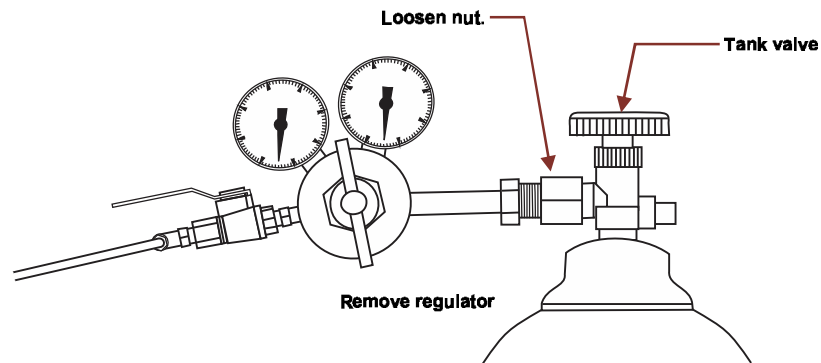

4. Prepare the new tank for use according to the supplier's instructions.
5. Insert the fitting on the pressure regulator into the nut on the tank and finger-tighten the nut:

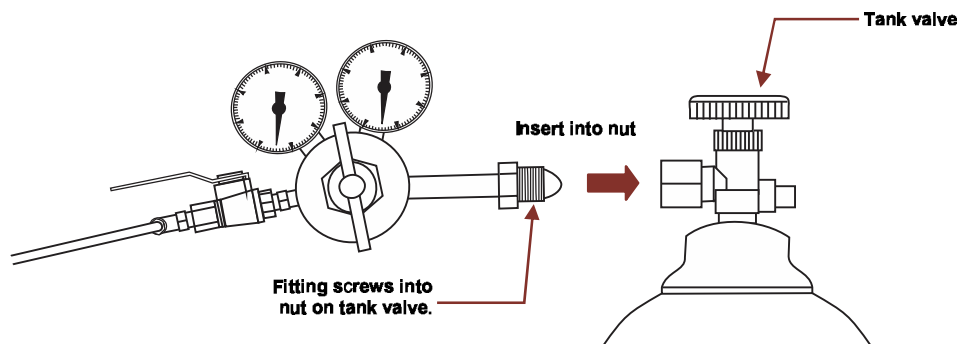

6. Use a crescent wrench to tighten it further. Make sure it is as tight as possible.
7. Turn the gas on at the tank. The tank pressure gage should show a full tank.
8. Set the gas line pressure by turning the pressure regulator valve (see section 3.4.4). It should be set to 20 psi (138 kPa) unless your lab has determined that another setting is more effective.



Reminder: Do not allow the gas line pressure to exceed 60 psi (414 kPa).

9. Open the gas line ball valve on the pressure regulator.
10. Check the fitting at the tank connection for leaks (see section 3.7).

► **To change gas mix supply tanks**

1. If there is any gas in the tank (pressure is greater than 0), turn off the tank valve.
2. Close the gas line ball valve on the gas pressure regulator.
3. Using a crescent wrench, loosen the nut on the pressure regulator by turning it to the right and remove the pressure regulator from the tank fitting:

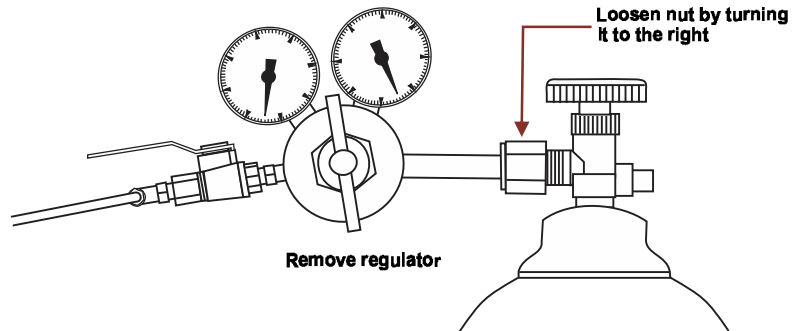

Note: This fitting is threaded opposite of standard.

4. Prepare the new tank for use according to the supplier's instructions.
5. Insert the threaded fitting into the nut on the pressure regulator. Fingertighten the nut by turning it to the left:

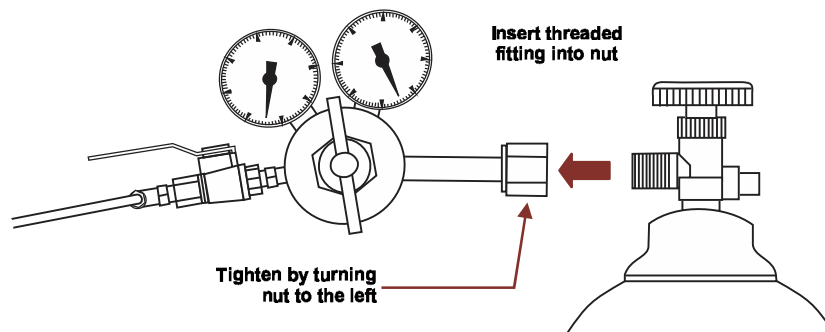

6. Use a crescent wrench to tighten it further. Make sure it is as tight as possible.
7. Turn the gas on at the tank. The tank pressure gage should show a full tank.
8. Set the gas line pressure by turning the pressure regulator valve on the pressure regulator (see section 3.4.4). It should be set to 20 psi (138 kPa) unless your lab has determined that another setting is more effective.



Reminder: Do not allow the gas line pressure to exceed 60 psi (414 kPa).

9. Open the gas line ball valve on the pressure regulator.
10. Check the fitting at the tank connection for leaks (see section 3.7).

3.7 Diagnosing Gas Line Leaks

As part of your regular maintenance outlined in Chapter 7, you will need to periodically check the gas lines for leaks. You should also check for leaks if you notice an unexplained drop in pressure and whenever you install a new tank.

► To check for leaks

1. Close the gas line ball valve on the pressure regulator of the line you are testing and watch the gas line pressure gage:
 - If the pressure does not drop within 10 minutes, there are no leaks.
 - If the pressure drops, there is a leak in the line.
2. To find the leak, do the following:
 - Make a solution of soap and water.
 - Brush the soap/water solution on all fittings.
 - If the solution bubbles, there is a leak in that fitting.



Note: *If you have purchased a gas leak detector, you can use it to check for leaks in the gas mix line instead of using the soap/water solution. You will still need to use the soap/water solution for the background gas line, as the gas leak detector only detects hydrogen.*

Alternatively, you can temporarily switch the gas mix and background gas lines in order to use the gas leak detector on the background gas line. Don't forget to re-attach them to the correct tanks after you are finished!

3. To fix the leak, do the following:
 - Tighten the fitting as much as needed to stop the leak.
 - If tightening the fitting doesn't stop the leak, the fitting may be damaged. If the fitting of interest is one of the fittings on the copper tubing, replace the copper tubing (see section 3.5). If it is one of the pressure regulator fittings, contact Coy.



Note: *If you have just replaced the copper tubing and the fitting appears to be stuck or is difficult to turn, the fitting may be cross-threaded (i.e., the threads of the fittings were misaligned when they were connected). In such cases, it is more than likely that one or both fittings have been damaged and will need to be replaced. Contact Coy or your local supplier.*

4 Operating the Automatic Airlock Controller

4

The airlock controller is accessed through the controller front panel. All airlock operations, whether automatic or manual, are performed through the front panel. You can set up your own profiles for automatic operation and change configuration settings to suit your needs:

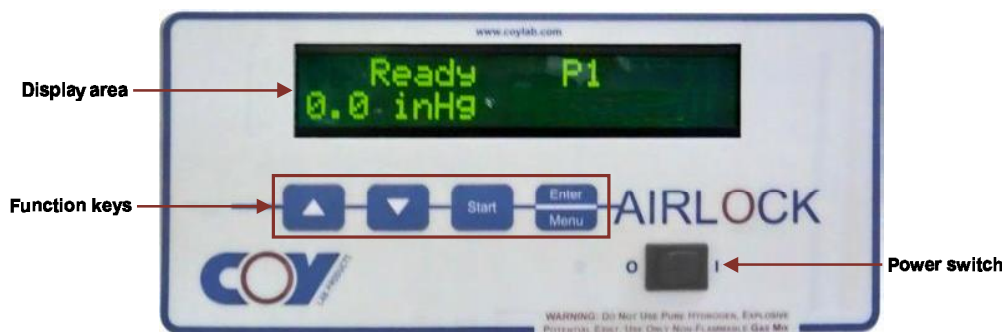

The controller front panel has a display area where messages and instructions are displayed and four function keys. How these keys operate depends on which mode of operation you are in.

4.1 Controller Basics

The purpose of the airlock is to act as a buffer between the aerobic laboratory environment and the anaerobic chamber environment. Whenever you transfer material to or from the chamber, the airlock must be brought to anaerobic conditions before the inner door of the chamber can be opened. The procedure for doing this is called a cycle.

A default factory cycle consists of two background gas cycles and one gas mix cycle:

- Vacuum the airlock and fill it with background gas.
- Vacuum the airlock and fill it with background gas a second time.
- Vacuum the airlock and fill it with gas mix.

These cycles can be performed either automatically or manually through the airlock controller. For automatic operation, profiles must be set up that specify how long each step of the cycle lasts and how many times each cycle is performed. Initially, all profiles perform the default factory cycle. You may need to make changes to the default profile settings for the airlock to function with your environment and your equipment. You can have up to nine different profile definitions, so you can create additional profiles to handle specific conditions or situations.



Warning: When transferring media in open containers, the containers should be covered, and extra care should be taken to avoid spills and broken glassware. The vacuum pump will draw the spilled moisture from the airlock during the vacuum process, and excessive amounts can cause permanent failure of the vacuum pump.

4.1.1 Starting the controller

For normal operation, you will not need to turn the controller on and off on a regular basis. However, you may have occasion to do so for maintenance purposes or to reset the controller after an error.

► **To turn the controller on and off**

To turn the controller on, set the power switch to **I**:



To turn the controller off, set the power switch to **O**.

When you turn the controller on, you will see the following display, which contains your airlock revision number, for a few seconds:



Then you will see one of the following messages:

- If the airlock is anaerobic:



- If the airlock is aerobic and the outer door is closed:



- If the outer door is open:







Note: If the outer door is open, you will not be able to operate the controller.

4.1.2 Accessing the menu

By default, the controller is always in automatic mode. To access other functions, you will need to access the menu.

The controller's main menu has four options:

Option	Function	Key
Profile menu	Allows you to set up airlock cycle profiles.	
Configuration menu	Allows you to configure airlock settings.	
Manual mode	Allows you to operate in manual mode.	
Exit	Exits the main menu.	

Within each of these options, the function keys will have different functions assigned.

► To access the menu

1. Press the  key. You will see the main menu display:



2. Press the key for the option you want and follow the instructions in sections 4.2, 4.3, and 4.4.



Note: There is no time limit for choosing a menu or for entering values or performing menu functions. The controller will maintain the menu display until you are finished.



Important: Values are not stored in the controller's memory until you press  to exit from the main menu.

4.2 Changing Configuration Settings

The configuration settings you may set are shown below:

Setting	Description	Default
Display in mbars	Determines whether the vacuum readings are displayed in inHg or mbar.	No
Pressure limit	Sets the gas pressure limit.	20*
Factory setting	Returns values to the factory setting.	Yes
Sensor zero Cal	Calibrates the sensors (initializes to 0).	Yes



*This value is set during factory testing and may be different for your airlock.

The default values are those that were set at the factory prior to shipment. For high altitude operation, you may need to change this setting prior to using the airlock for the first time.

4.2.1 Using the configuration menu

The setting options are displayed in the above order after you select the menu.

► To enter configuration settings

1. Press the  key from the main menu to select the configuration menu.
2. The menu items will be displayed one by one. Instructions for changing their settings are given in sections 4.2.2–4.2.5.
3. When you are finished with one item, the next one will be displayed.
4. To skip a menu item completely, simply press  unless otherwise directed in the instructions.



4.2.2 Setting the vacuum reading display

When you press  to enter the configuration menu, the following message will appear:



You may display the vacuum readings in either mbar (millibars) or inHg (inches of mercury). The default setting is inHg.

► To select the vacuum reading display

1. Select the display you want:
 - To display the vacuum reading in mbar, press the  key.
 - To display the vacuum reading in inHg, press .
2. After you make your selection, the next menu item will be displayed.



Note: You must press either  or . If you don't want to change the setting, simply press the key for the current setting.

4.2.3 Setting the gas pressure limit

After you have responded to the previous item, the following message will appear in the display area:

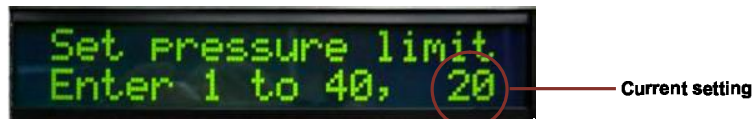



The gas pressure limit sets the amount of gas pressure allowed to enter the airlock after the vacuum reading reaches 0 inHg (0 mbar). The current value will appear in the display area. The default setting is nominally 20, but, since the actual value is determined by factory testing, your default value may be different. There is no reason to change this value unless:

- Your airlock doors will not open. This indicates that excessive vacuum is still present and the gas pressure must be increased.

- Gas is escaping from one or both of the airlock doors. This indicates that the gas pressure is too high and needs to be decreased.

The setting for this limit can be anywhere from 1 to 40. Adding 1 to the current value increases the pressure by about 0.0043 psi (0.03 kPa). Decreasing the value by 1 will decrease the pressure setting by that amount. A value of 40 sets the pressure to 0.172 psi (1.19 kPa).

► To set the gas pressure limit

1. The current limit will be displayed below the message:
 - To increase the displayed value, press the  button.
 - To decrease the value, press the  button.

Each time you press the key, the value will increase or decrease by 1.



Note: *The value will not change until you release the key. You cannot hold the key down for a continuous increment or decrement.*

2. When you are finished, press  to go to the next menu item.

► To test your new setting

Select and run a profile (see section 4.4.1) to see if the new values work with your airlock:

- If you are unable to open your airlock doors after a cycle, you will need to increase this value to relieve the excess vacuum.
- If excess gas escapes from one or both airlock doors, you may need to decrease the value. However, if one of the doors will not open as a result of the decreased value, the higher value is probably correct. The door that is allowing the excess gas to escape (presumably the one that opens) may need tightening. Check the airlock seal for leaks and adjust the door if necessary (see section 7.7 in Chapter 7 for instructions). If this does not solve the problem, contact your service or maintenance personnel or call Coy technical support.



Note: *You will need to complete the configuration menu sequence before you can test your setting.*

4.2.4 Restoring the factory settings

After you finish with the gas pressure limit, you will see the following prompt:



```
FACTORY SETTING
UP=Yes, Menu=No
```

This option allows you to return to factory settings in one operation if your changes do not work out instead of changing them back individually.

The following values are set at the factory for each of the nine profiles:

Item	Default
Number of gas mix cycles	1
Number of Purge gas cycles	2
Vacuum time out	45 s
Purge gas time out (both purge gas and gas mix)	45 s
Vacuum limit	20 inHg

The following values are set at the factory for the configuration settings:

Item	Default
Display In mbars	No
Pressure Limit	20*
Factory Setting	Yes
Sensor Zero Cal	Yes

* This number may vary, based on factory testing.

You can restore the configuration factory settings and the factory settings for profile 9. The other profiles will remain unchanged.

► **To restore the factory settings**

1. To restore the factory settings, press . The following message will be displayed:



Then you will go on to the next menu item.

2. To leave the settings unchanged, press the  key to go on to the next menu item.

4.2.5 Setting the sensor zero calibration

After you leave the factory settings menu, the following message will be displayed:



The pressure sensors are initially calibrated to 0 at the factory, zero being the point at which there is no gas or vacuum pressure in the airlock. You may wish to recalibrate in your own environment if your pressure readings do not appear to be accurate.

► **To set the sensor zero calibration**

1. Do one of the following:
 - Press  to exit the configuration menu without recalibrating the sensors,
 - To recalibrate the sensors, continue with step 2.

2. Press the  key. The controller will display the instruction:



This message will remain until the outer door is opened.

3. Close the inner door and open the outer door. After the outer door is opened, calibration will start. While it is calibrating, you will see a numeric display on the top line:

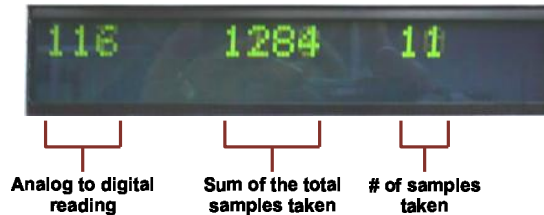

4. After the calibration is calculated, you will see the following message:



Then you will automatically exit the configuration menu.



Warning: *The sensor cannot tell whether the inner door of the airlock is closed. Make sure that it is latched and locked before you open the outer door or you will lose your anaerobic environment.*

4.3 Setting Up Profiles

The profile menu allows you to create to nine airlock cycle profiles that you can run automatically. There are five values for a given profile:



Value	Description	Default
Number of gas mix cycles	The number of times you want to vacuum and fill the airlock with gas mix.	1
Number of purge gas cycles	The number of times you want to vacuum and fill the airlock with background gas.	2
Vacuum time out	The number of seconds before the vacuum pump will time out if it doesn't finish the vacuum process.	45 s
Purge gas time out	The number of seconds before the purge gas or gas mix will time out if it doesn't finish filling the airlock.	45 s
Vacuum limit	The pressure to which the airlock is to be vacuumed.	20 inHg (677 mbar)

Initially all nine profiles are set to the default values. To create your own, you simply select a profile and change the values.





4.3.1 Using the profile menu

To use the profile menu, you must first select the profile you want to edit. The menu items will be displayed in the above order after you select the profile.

► To select a profile

1. Press  to enter the main menu. Then press  to select the profile menu. The following message will appear:



2. The number of the last profile edited or executed will be displayed on the second line:
 - To select a higher number, press the  key. Each time you press , the value will increment by 1.
 - To select a lower number, press the  key. Each time you press , the value will decrement by 1.
3. When you have selected the profile you want to edit, press the  key and the first profile item will appear.

► To enter profile settings

1. The menu items will be displayed one by one. Follow the instructions in sections 4.3.2 through 4.3.6 for the displayed item.
2. When you are finished with one item, the next one will be displayed.
3. To skip a menu item completely, simply press  unless otherwise directed in the instructions.

4.3.2 Entering the number of gas mix cycles

After you have selected the profile you want to edit, the following message will appear:

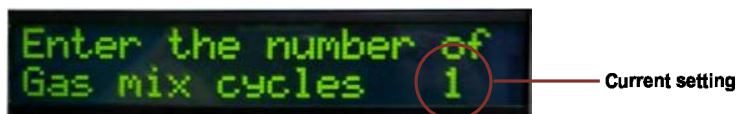

The current value will be displayed in the message.





A gas mix cycle consists of vacuuming the airlock to remove the background gas and filling it with the gas mix. You may perform up to 9 cycles. The default setting is 1.

You may also specify 0 cycles if you do not want to perform any gas mix cycles. If you enter 0, the program will skip over the gas mix portion of the program when the profile is run.



Note: For a profile to be valid, you must have at least one gas mix cycle or one purge cycle.

► **To enter the number of gas mix cycles**

1. The current setting for the number of gas mix cycles will be displayed. If you want to change the current setting, select a value between **0** and **9**:
 - To select a higher number, press the  key. Each time you press , the value will increment by 1.
 - To select a lower number, press the  key. Each time you press , the value will decrement by 1.
2. When you have entered the number of cycles you want, press the  key to go to the next item in the menu.

4.3.3 Entering the number of purge gas cycles

After you have entered the number of gas mix cycles, the following message will appear:



The current setting will be displayed in the message.





The purpose of the purge gas cycle is to remove the oxygen from the airlock. It consists of vacuuming the airlock to remove the current atmosphere and filling it with background gas (usually nitrogen). You may perform up to 9 cycles. The default setting is 2.

You may also specify **0** cycles if you do not want to perform any purge gas cycles. If you enter **0**, the program will skip over the purge gas portion of the program when the profile is run.



Note: For a profile to be valid, you must have at least one gas mix cycle or one purge gas cycle.

► **To enter the number of purge gas cycles**

1. The current setting for the number of purge gas cycles will be displayed in the message. If you want to change the current setting, select a value between **0** and **9**:
 - To select a higher number, press the  key. Each time you press , the value will increment by 1.
 - To select a lower number, press the  key. Each time you press , the value will decrement by 1.
2. When you have entered the number of cycles you want, press the  key to go to the next menu item.



Note: If you enter **0** cycles for both the gas mix and the purge cycle, the controller will display the following error message and sound an alarm:

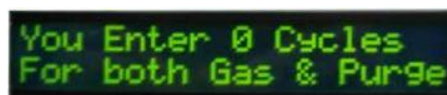

After a couple of seconds, the controller will take you to the beginning of the profile menu.

4.3.4 Entering the vacuum time out

After you have entered the number of purge gas cycles, the following message will appear:







The vacuum time out is the number of seconds allowed for the vacuum process to reach the vacuum limit. When the profile is run, an alarm will sound if your vacuum limit isn't reached within that number of seconds. The default setting is 45 seconds and is a "safe" setting for most installations.

If the vacuum pump times out consistently during automatic operation, the cause may be one of the following: (1) leaks in the airlock, (2) a faulty vacuum pump, (3) a changed vacuum level (see note below), (4) decreased pressure due to high altitude operation. For reasons 3 and 4, this setting will need to be increased.



Note: If you increase the vacuum level limit above the 20 inHg default, you may need to increase this setting. If your lab operates at a high altitude, you may also need to increase this setting.

► To enter the vacuum time out

- The current setting for the vacuum time out will be displayed. You may change this value to any value between 45 and 120 in five-second increments:
 - To select a higher value, press the  key. Each time you press , the value will increment by 5.
 - To select a lower value, press the  key. Each time you press , the value will decrement by 5.
- When you have entered the number of seconds you want, press the  key to go to the next item in the menu.

4.3.5 Entering the purge time out



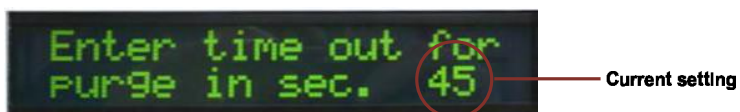

After you have entered the vacuum time out, the following message will appear:



The purge time out is the number of seconds allowed for the airlock to reach 0 inHg (0 mbar) when being filled with gas (either background gas or gas mix). When the profile is run, an alarm will sound if the airlock does not reach 0 inHg (0 mbar) within that number of seconds. The default setting is 45 seconds.

This setting is primarily used to alert users to low gas tanks, as the decreased pressure of a low tank will cause the gas to fill the airlock more slowly. If the pressure is too low, the purge will time out. If this error occurs frequently and gas tank levels should be adequate, either increase the gas line pressure or decrease the distance the gas travels by installing a shorter line. If neither of the above are possible, only then should the time out for purge be increased.

► **To enter the purge time out**

1. The current setting for the purge time out will be displayed in the message. You may change this value to any value between 45 s and 120 s in five-second increments:
 - To select a higher value, press the  key. Each time you press , the value will increment by 5.
 - To select a lower value, press the  key. each time you press , the value will decrement by 5.
2. When you have entered the number of seconds you want, press the  key to go to the next item in the menu.

4.3.6 Setting the vacuum limit

After you have entered purge time out, the following message will appear:

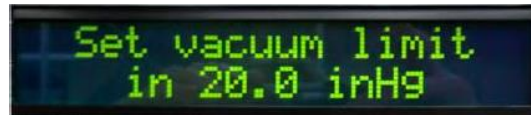





The vacuum limit sets the level you want to vacuum the airlock to. The current setting will appear in the bottom line of the message. Depending on what is currently selected for your airlock, it will either be displayed in inHg (inches of mercury) or mbar (millibars).

The limit can be set between from 5 inHg (169 mbar) to 29.9 inHg (1012 mbar). The default value is 20 inHg (677 mbar). The value that you set will depend on your vacuum pump's capabilities. The pump supplied by Coy is capable of approximately 24 inHg (813 mbar).



Note: When the Coy-supplied pump nears its upper limits (22 inHg to 24 inHg), it takes much longer to reach the vacuum limit than with lower vacuum levels. You may have to adjust the vacuum time out if a higher setting is desired.

► **To set the vacuum limit**

1. The current vacuum limit will be displayed in the message. You may change this value to any value between 5 inHg (169 mbar) and 29.9 inHg (1012 mbar) in 0.1 increments:
 - To select a higher value, press the  key. Each time you press , the value will increment by 0.1.
 - To select a lower value, press the  key. each time you press , the value will decrement by 0.1.
2. When you have entered the limit value you want, press the  key to exit the profile menu.

4.4 Running the Airlock in Automatic Mode

When the airlock is first turn on, the controller will display the following:



Then the controller will enter automatic mode:

- If the airlock is anaerobic, the following message will be displayed:



The last profile accessed will be displayed in the first line.

- If the airlock is aerobic and the outer door is closed, “aerobic” will be displayed in the message and “ready” will appear on the first line, indicating that the unit is ready to be cycled:



- If the outer door is open, “Open door” will be displayed on the first line instead:



The door must be closed before you can proceed.

When the airlock is in operation, the second line will display the current vacuum reading in inHg or mbar (depending on the configuration setting selected).



Note: The vacuum reading will not be displayed during timeout errors and when you are in the menus.







4.4.1 Running a profile

Running a profile to create an anaerobic environment in the airlock is automatic. All you need to do is make your selection and start the execution. No further input is needed unless errors occur.

► **To run a profile**

1. Make sure the inner door of the airlock is latched and locked.
2. Close and lock the outer door. **Aerobic** will be displayed on the second line:



3. The last profile selected will be displayed on the first line. Use  and  to select a different profile:
 - To select a higher number, press the  key. Each time you press , the value will increment by 1.
 - To select a lower number, press the  key. Each time you press , the value will decrement by 1.

4. When you have selected the profile you want, press  and the profile will run. When it is finished, an alarm will sound. The display will read:



4.4.2 Handling errors

If an error occurs, the controller will stop and an alarm will sound. The error that occurred will be displayed in the display area. There are four possible errors. Follow the instructions in the table below for handling the error:

Message	Description	Action
Error 01	The profile you are running has 0 cycles for both the gas mix and the purge gas.	<ol style="list-style-type: none"> 1. Turn the power off and back on to clear the error. 2. Edit the profile to correct the error (see section 4.3).
Timeout Error Vacuum	<p>The airlock did not reach the vacuum limit set in the profile in the specified time (factory default is 45 seconds).</p> <p>Note: The action procedure you follow depends on the version number of your airlock. You can determine the version of your airlock by turning the controller off and back on. The Rev # of your airlock will be displayed.</p> <p>High altitude operation: At high altitudes, the vacuum pump will take longer to reach the same levels than it would at sea level. You may have to increase the amount of time for the appropriate vacuum levels to be reached.</p>	<p>Rev. 1.3 and below:</p> <ol style="list-style-type: none"> 1. Press and release  to open the purge gas solenoid and bring the vacuum to 0 inHg (0 mbar). 2. Turn the power off and back on. 3. If the vacuum pump starts, check the following: <ul style="list-style-type: none"> ● Check to see if the doors are closed, latched, and locked. ● Check the vacuum limit in the profile (section 4.3.6). The pump may not be able to reach this limit. 4. If neither of the above is the case and the problem continues, you may need to increase the timeout value. See section 4.3.4. <p>Note: If the vacuum pump does not start, the pump fuse may have blown.</p> <p>Rev. 1.5 and above:</p> <ol style="list-style-type: none"> 1. Turn the power off and back on to clear the error. 2. Manually purge the airlock to 0 inHg (0 mbar). See section 4.5. 3. If the vacuum pump starts, check the following: <ul style="list-style-type: none"> ● Check to see if the doors are closed. ● Check the vacuum limit in the profile (section 4.3.6). The pump may not be able to reach this limit. 4. If neither of the above is the case, run the profile again. If the problem continues, you may need to increase the timeout value. See section 4.3.4. <p>Note: If the vacuum pump does not start, the pump fuse may have blown.</p>



Message	Description	Action
Timeout Error Purge Gas	The airlock did not return to 0 inHg (0 mbar) in the specified time set in the profile.	<ol style="list-style-type: none"> 1. Turn the power off and back on to clear the error. 2. Check the background gas tank pressure setting on the pressure regulator to make sure it has gas. 3. Make sure the background gas line has adequate gas pressure (see Chapter 3, section 3.4). 4. Make sure the gas line ball valve on the gas regulator is open. 5. Check for leaks in the gas line. 6. Check the purge timeout limit in the profile (section 4.3.5). You may need to increase the limit.
Timeout Error Gas Mix	The airlock did not return to 0 inHg (0 mbar) in the specified time set in the profile.	<ol style="list-style-type: none"> 1. Turn the power off and back on to clear the error. 2. Check the gas mix tank pressure setting on the pressure regulator to make sure it has gas. 3. Make sure the gas mix line has adequate gas pressure (see Chapter 3, section 3.4). 4. Make sure the gas line ball valve on the gas regulator is open. 5. Check for leaks in the gas line. 6. Check the purge timeout limit in the profile (section 4.3.5). You may need to increase the limit.

4.5 Operating the Airlock in Manual Mode

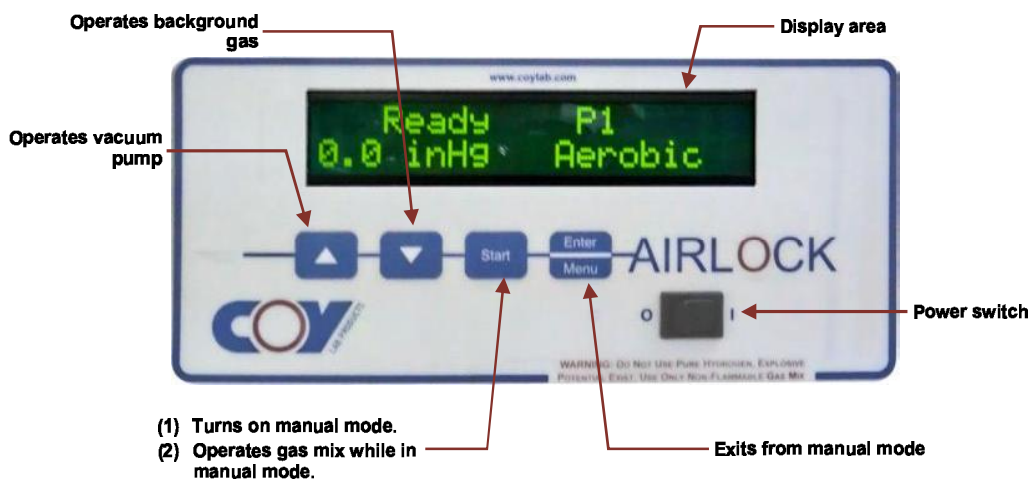
In manual mode, the keys on the controller are assigned special functions to operate the vacuum pump and the gas lines:



► **To operate the automatic airlock manually**

1. Make sure the gas line ball valves for both gases are open (see section 3.4.4 of Chapter 3).
2. Press  to enter the main menu.
3. Press the  key to enter manual mode. The manual mode key functions will be displayed in the display area:



Manual Mode
Up=Vac. & Down=P.Gas



Manual Mode
Start=G.Mix Menu=Ex.

Wait until the display is finished (about 6 seconds) before you proceed.

► **To operate the background gas**

1. Press the  key and hold it down to start the gas flow.
2. Release the key to turn the gas flow off.

► **To operate the vacuum pump**

1. Press the  key and hold it down to run the vacuum pump.
2. Release the key to turn the pump off.

► **To operate the gas mix**

1. Press the  key and hold it down to start the gas flow.
2. Release the key to turn off the gas flow.

The manual mode function keys may be used to simulate an automatic airlock cycle. This may be necessary if a cycle times out and needs to be completed. Manual mode is also used when performing some maintenance functions, such as replenishing the hydrogen.

During manual operation, the display will show the vacuum pressure reading:



0.0 inHg

It increases while the airlock is vacuumed and decreases when it is filled with gas.



Note: The units will be displayed in inHg unless your airlock has been set to display in mbar. See section 4.2.2.

4.6 Operating with the Manual Control Switches

The airlock can also be operated from the manual control switches on the back of the airlock. These switches are intended for airlock operation if the controller

fails and should not be used as a standard method of operation. They operate independently of the controller and do not communicate with the controller. You have no display information (e.g., vacuum pressure readouts). The power switch on the controller must be turned off for the manual switches to operate.

Because there is no display information, you will need some method of determining the length of time to perform each phase of the airlock cycle. To be prepared for emergency operation, you should perform a cycle manually through the controller and time the following operations:

- Vacuum the airlock to 20 inHg (677 mbar).
- Fill the airlock with background gas. Note the background gas pressure during this operation.
- Fill the airlock with gas mix. Note the gas mix pressure during this operation.

Store the times and the gas pressure readings in a safe place, so you will have them available in case of controller failure.



Note: *The gas pressure directly affects the time it takes to fill the airlock, as the gas flow is slower when pressure is lower.*

► **To perform a cycle with the manual control switches**

1. Turn off the power switch on the control panel.
2. Close the inner door of the airlock. Make sure it is latched and locked.
3. Make sure the outer door of the airlock is latched and locked. This door is not monitored when you are operating without the controller.
4. Set the gas line pressure on the gas pressure regulators to the pressure that was used when you timed the fill operations.
5. Hold the vacuum switch down to vacuum the airlock for the length of time you determined was necessary. Then release the switch.
6. Hold the nitrogen switch down to fill the airlock with background gas. Release the switch when the predetermined time has expired.
7. Vacuum the airlock for the predetermined length of time again.
8. Fill the airlock with background gas again. Release the switch when the predetermined time has expired.
9. Vacuum the airlock for the predetermined length of time once more.
10. Hold the gas mix switch down for the predetermined time to fill airlock with gas mix. Then release the switch. If your times were accurate, the airlock should now be anaerobic.



Note: *Due to barometric pressure changes, the timed operation may be off slightly in which case you may need to purge for 1 or 2 seconds longer or shorter. Shorten the purge time if you hear gas escaping from the door. Lengthen the purge time if the door cannot be opened, which indicates that the gas has not fully filled the airlock and some vacuum pressure still exists.*

5 Catalyst Fan Box Operation

5

Catalyst fan boxes circulate the chamber's atmosphere through palladium catalyst, which, in the presence of hydrogen, removes oxygen. This circulation also provides a homogeneous mix of gases in the chamber.

5.1 Catalyst Fan Box Features

Catalyst fan boxes may be either heated or unheated, depending on chamber requirements. Power for the units is supplied through the 6-receptacle power strip that is supplied with all Coy chambers.

5.1.1 Heated catalyst fan boxes

The heated catalyst fan box is used for chambers without incubators where it is important to control the chamber's temperature:



The temperature is set through the control panel on the front of the box. Heat is provided through two heating cones, which are installed behind the heat shield.

The standard heated catalyst box can maintain the chamber's temperature from ambient to about 40 °C. A high-range version can maintain temperatures to 50 °C. The controller automatically turns the heating cones on and off as needed to maintain the desired temperature. The fan operates continuously to circulate the chamber's atmosphere while the power is on, regardless of whether the heating cones are operating.

5.1.2 Unheated catalyst fan boxes

The unheated catalyst fan box is used for chambers that do not need temperature control and chambers with a separate incubator. They do not have a controller or sensor, but the other parts of the fan box are the same:



The unheated catalyst box is powered up whenever the chamber power strip is turned on. The fan is turned on immediately and runs continuously to circulate the chamber's atmosphere.

5.2 How the Fan Box Works

A Stak-Pak containing the palladium catalyst is placed in the Stak-Pak holder in front of the catalyst fan box:

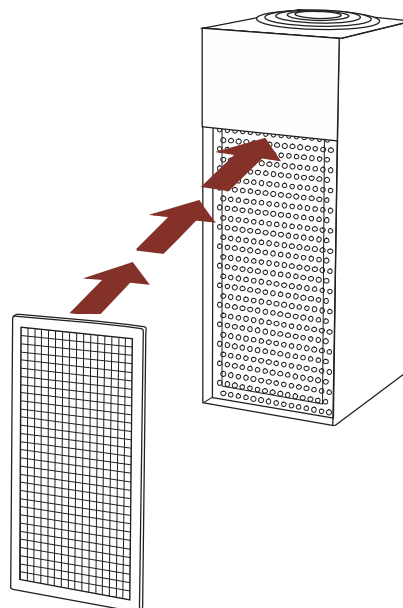

The fan draws the chamber atmosphere through the top of the fan box and blows it out through the front:

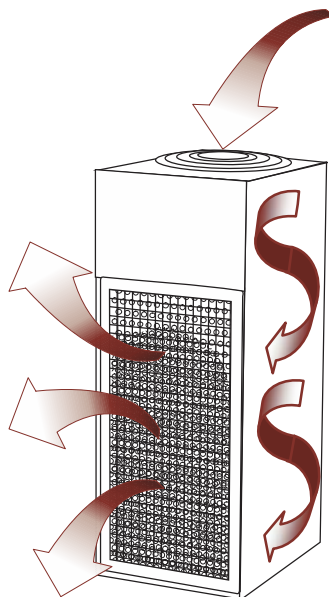

As it passes through the palladium catalyst, the hydrogen and oxygen molecules form water molecules, removing oxygen from the chamber. The water is absorbed by the alumina pellets.

The heated catalyst fan box has an **On/Off** switch and must be turned on for the fans to operate. The fans operate continuously when the box is turned on. The unheated catalyst box does not have an **On/Off** switch and operates continuously when the chamber power strip is powered up.

5.3 Positioning Catalyst Fan Boxes in the Chamber

Ideally, for best performance, catalyst fan boxes should be positioned vertically with the heat shield facing the center:



The following guidelines should be applied when determining the optimal location for a catalyst fan box. If you need to reposition a catalyst fan box for any

reason, keep these guidelines in mind. If you were involved in setting up the chamber, you are probably already familiar with them:

- In chambers with two catalyst fan boxes, the fan boxes should be placed on opposite sides of the chamber for more efficient atmosphere circulation (see illustrations in setup manual). This spacing is particularly important for heated catalyst fan boxes in order to optimally control the ambient temperature.
- In chambers with one catalyst fan box, the fan box should be placed near the airlock for more efficient removal of oxygen that enters through the airlock. Oxygen levels are at their highest point after an airlock cycle.
- Catalyst fan boxes should never be positioned with either the fan cage or the Stak-Pak holder resting against any of the chamber walls or under a shelf, as fan box efficiency decreases sharply.
- In Type C chambers, an incubator or a set of 36 in (91 cm) shelves will take up the entire rear of the chamber, leaving no room for the one catalyst fan box. In this case, the fan box may be placed horizontally on its side on top of the incubator or shelf unit:



The heat shield should be facing forward and the fan cage should not be blocked by any equipment.



Note: You may also use the above solution for any configuration with two catalyst fan boxes where there is no room to place both catalyst boxes on the chamber floor. In such cases, the fan box nearest to the airlock should be placed vertically on the floor. The one on the opposite side can be placed horizontally on whatever component is available (e.g., on the top of a shelving unit).



Note: Four rubber feet are provided for each box. They are attached during setup to the side the box is resting on. If you change the position of a catalyst box from vertical to horizontal or vice versa, you will need to change the position of the feet. If the original adhesive doesn't stick, use double-sided tape to secure the feet to the box.

5.4 Catalyst Stak-Paks

The catalyst Stak-Pak contains alumina (aka aluminum oxide, Al_2O_3) pellets coated with a thin layer of palladium chloride:



The alumina absorbs the water molecules that are formed when hydrogen and oxygen meet in the presence of the palladium chloride catalyst. The water is removed when the Stak-Pak is rejuvenated (see section 5.4.3).

Coy provides two catalyst Stak-Paks for each catalyst fan box in your chamber. Only one catalyst Stak-Pak at a time is installed in a catalyst fan box. The other is a spare to be installed when the one in use needs rejuvenating.

5.4.1 Inserting the Stak-Paks into the Stak-Pak holders

Stak-Paks are easily inserted into the fan box Stak-Pak holders.

► To insert a Stak-Pak into a Stak-Pak holder

1. Place the bottom of the Stak-Pak behind the hook at the bottom of the fan box:

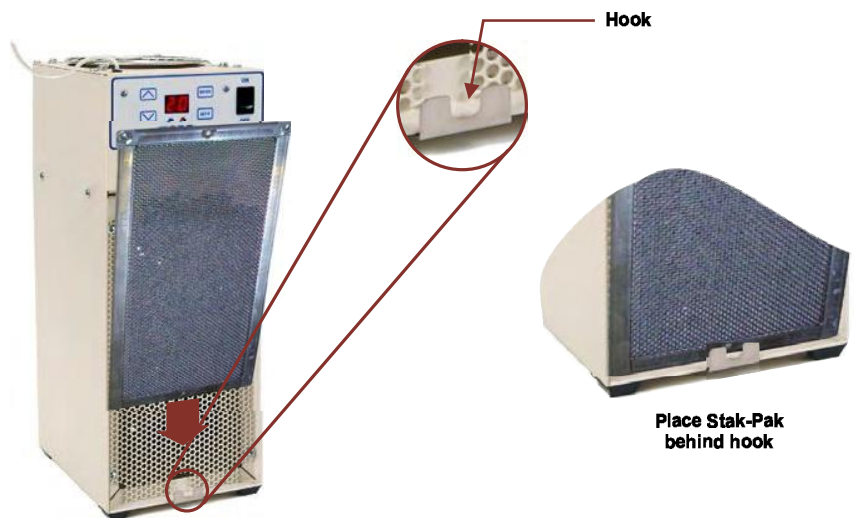

2. Push the top back into the recessed area of the box until it is against the heat shield and hooks under the clip:



5.4.2 Changing Stak-Paks

The catalyst Stak-Paks enter the chamber through the airlock. When you pass the Stak-Paks through the airlock, you must be very careful to maintain the chamber's anaerobic environment. The inner door must be closed before the fresh Stak-Pak(s) can be placed in the airlock. After you place the Stak-Pak(s) in the airlock, the airlock must be cycled to anaerobic conditions before the inner door can be opened to access the Stak-Pak(s). When you place the used Stak-Paks in the airlock, be sure to close and lock the inner door before you open the outer door to retrieve them.

5.4.3 Rejuvenating Stak-Paks

The water that is produced during the oxygen removal process is absorbed by the alumina pellets. As the absorbed moisture accumulates, it reduces catalyst efficiency. So, periodically, the catalyst must be rejuvenated to remove the moisture from the alumina pellets.

To rejuvenate the catalyst, place the Stak-Paks in an oven at 125 °C to 200 °C for two hours. The catalyst usually needs to be rejuvenated every 5 to 10 days. If you have a busy chamber, you may have to rejuvenate more frequently. Chapter 7 contains additional recommendations.

Two sets of catalyst Stak-Paks are included in your chamber package. That way you can have a rejuvenated extra set ready for use. When the Stak-Paks currently in use require rejuvenation, you can replace them with the freshly rejuvenated set.



Important: *Stacking two or more catalyst Stak-Paks together will not create a stricter or more efficient chamber. In some instances, it can hamper normal chamber operation by blocking or reducing airflow, which can throw off temperature uniformity.*

5.4.4 Testing catalyst effectiveness

Over time, the catalyst will lose its effectiveness. Coy recommends replacing the catalyst once a year as a general rule. However, in some environments, it may need changing more often. So we recommend occasional testing, especially if you have a busy chamber or if the oxygen level is consistently high, even after the hydrogen level has been refreshed.

► To test the catalyst effectiveness

1. Place a metal pan containing catalyst inside the airlock.
2. Place a thermometer in direct contact with the catalyst.
3. Vacuum the airlock and back fill it with the gas mix.
4. If the catalyst is working correctly, the temperature will increase due to the reaction of catalyst, oxygen, and hydrogen—about 10 °C over 10 to 15 minutes.

5.5 The Heated Fan Box Controller

The heated catalyst fan box controller maintains the temperature you specify for your chamber. The control panel on the front of the fan box is used to set the temperature for the controller:

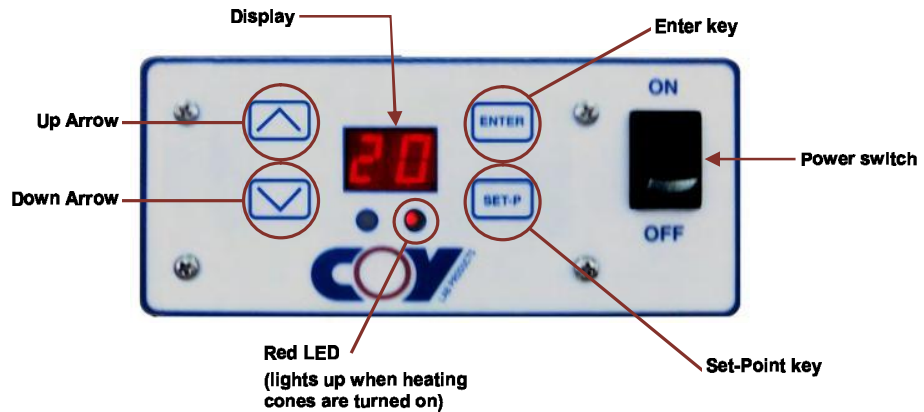

5.5.1 How the controller works

In addition to a fan, the heated catalyst fan box has two heating cones, a temperature sensor, and a variable thermostat. The current temperature is displayed on the control panel. The set point for the controller thermostat is set through the control panel. The set point is initially set during setup. You may change it if you determine it should be higher or lower.

When the chamber temperature at the location where the sensor has been placed drops below the set point temperature, the heating cones are turned on. Heat is blown into the chamber by the fan as it circulates the chamber atmosphere. When the set point is reached, the controller turns the heating cones off. The red LED on the control panel will light up whenever the heating cones are operating.

If you need to “turn off the heat” for any reason, you simply change the set point to a temperature well below the ambient temperature. Since that temperature is never reached, the heating cones will not be turned on. The fan will continue to operate.

5.5.2 Sensor location

The sensor should be located in the area where the temperature is most critical. The location should provide good airflow around the sensor to ensure accurate sampling.

The sensor can be attached to any piece of equipment in the area with the adhesive-backed clip provided by Coy:



The clip may be placed anywhere on the sensor cable, but it should be no close to the sensor than shown in the picture below:

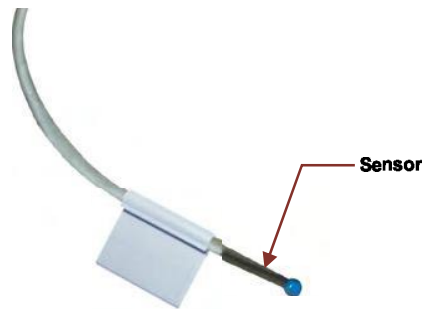

The sensor location is initially established during setup. If you need to reposition the sensor for any reason, peel the clip off the surface it is attached to and place it in its new location. If the clip will no longer adhere to the surface, either use a piece of double-sided tape to remount it or replace the clip.



Important: Make sure the blue tip of the sensor does not touch the component it is attached to or anything else in the surrounding area.

5.5.3 Setting the temperature set point

The temperature set point is set through the control panel on the front of the heated catalyst fan box.

► To set the set point

1. Press . The display will show the current set point.
2. Use the arrow keys to change the set point:
 - Press to increase the value.
 - Press to decrease the value.

Hold the key down until the temperature you want to maintain is displayed. Then release the key.

3. Press to enter the value into the controller.



Note: You must hold the key down to change the value. Pressing and releasing the key will not change the value.





Important: The controller will not accept the new value unless you press .

5.5.4 The hidden menu





The controller also has a hidden menu. The hidden menu is used to change internal values:

Value	Description
OF	<p>Offset. A value representing the difference between the actual chamber temperature and the temperature sensed by the sensor. Used in controller calibration.</p> <p>Important: Do not change this value unless you are calibrating the controller (see section 5.6).</p>

Value	Description
HL	High limit. The highest set point that can be set for the fan box. By default, they are set to the highest temperature the fan box is capable of maintaining (43 °C for standard boxes and 50 °C for high range boxes). You cannot set it above this value. There is no need to change it unless you want to set a lower limit for some reason.
CO	Cooling. Enables or disables fan box cooling if the fan box has that option. Catalyst fan boxes do not have this feature so it is disabled. The values 0 (off) and 1 (on) are ignored.







When you are in the hidden menu, the  and  keys are used to raise and/or lower the value in increments of 1, just as they are when setting the set point. If you do not wish to change the displayed value, simply press  to go on to the next menu item.

► To use the hidden menu



1. Press  and hold it down.
2. When **OF** appears in the display, release the  key.
3. Press  again and the **OF** (offset) value will be displayed:
 - To change this value, use the  and  keys to raise or lower the value. Hold the key down until the value you want is displayed.
 - To leave the value as-is, go on to step 4.



Important: Do not change this value unless you are performing a calibration procedure, as specified in section 5.6!

4. Press  and **HL** will appear in the display.
5. Press  again and the **HL** (high limit) value will appear:
 - To change this value, use the  and  keys to raise or lower the value. Hold the key down until the value you want is displayed.
 - To leave the value as-is, go on to step 6.
6. Press  and **CO** will appear in the display.
7. Press  again and the **CO** (cooling) value will appear.
8. Since **CO** is disabled, press  to exit the hidden menu.



Note: There is a 2-minute delay for each item in this menu. The delay will restart whenever the  key is pressed. If you have not pressed  in that time frame, the controller will exit from the hidden menu.

5.6 Calibrating the Controller

The heated fan box controller is calibrated to 37 °C at the factory, regardless of whether it is a standard or high-range unit. However, over time, the sensor may “drift” (i.e., it starts reporting the temperature either lower or higher) and controller heating accuracy may be compromised. Normally, the controller needs to

recalibrated about once a year. However, if you find that the temperature is no longer being maintained accurately, you may wish to recalibrate before the next scheduled recalibration. High altitudes and extreme external conditions may also affect the performance of the controller, in which case the controller may need calibration at setup time.

When you calibrate the sensor, you determine the difference between the chamber temperature and the temperature reported by the sensor. That difference determines the “offset” value, which is an arbitrary number. The controller uses this offset value to reconcile the reported temperature with the actual chamber temperature. Accuracy decreases slightly for temperatures that are further away from the calibration point, but the difference is generally minimal.

In general, both standard and high range units should be calibrated 37 °C. However, when calibrated at 37 °C, the accuracy of the temperature at 50 °C is within 2 degrees. If your chamber activities require the temperature to be more accurate at 50 °C, you should calibrate the unit to 50 °C instead to allow more accuracy at higher temperatures.



Note: *Because vinyl chambers are not insulated, the highest uniform temperature you can achieve is 50 °C. For higher temperature performance, you should consider the Coy model 2000 high range incubator.*

The numbers in the **OF** display are arbitrary and do not represent the actual temperature setting. The value range is from 1 to 30. 15 is the midpoint. The offset value is calibrated to 0.5 increments. However, the controller only handles whole numbers, so each whole number represents 0.5 °C. The controller translates this value to an offset value and either adds to or subtracts from the sensor reading to determine the actual temperature.



Note: *The instructions below calibrate the sensor at 37 °C. To calibrate at 50 °C, set the set point at 50 °C and perform all calculations based on 50 °C instead of 37 °C.*

► **To recalibrate the controller**

1. Place a reliable thermometer as close to the sensor as possible.
2. Set the controller set point to 37 °C.
3. Allow the instrument to stabilize for 30 to 40 minutes. Then read the thermometer and determine the difference:

- If the thermometer temperature is lower than 37 °C, subtract the temperature from 37:

Thermometer read: 35
Difference: 37 – 35 = 2

- If the thermometer temperature is higher than 37 °C, subtract 37 from the temperature:

Thermometer read: 38.5
Difference: 38.5 – 37 = 1.5

4. Multiply the difference value calculated in step 3 by 2 to determine the number of 0.5 °C units:

Thermometer read: 35
Difference: $37 - 35 = 2$
0.5 °C units: $2 \times 2 = 4$





Thermometer read: 38.5
Difference: $38.5 - 37 = 1.5$
0.5 °C units: $1.5 \times 2 = 3$

5. Access the hidden menu (see section 5.5.4) and display the **OF** value:
- If the temperature displayed by your thermometer is less than 37 °C, subtract the value calculated in step 4 from the current **OF** value:

Thermometer read: 35
Difference (step 3): $37 - 35 = 2$
0.5 °C units (step 4): $2 \times 2 = 4$
Current OF value: 21
New OF value: $21 - 4 = 17$

- If the thermometer temperature is greater than 37 °C, add the value calculated in step 4 to the current **OF** value:

Thermometer read: 38.5
Difference (step 3): $38.5 - 37 = 1.5$
0.5 °C units (step 4): $1.5 \times 2 = 3$
Current OF value: 21
New OF value: $21 + 3 = 24$

6. Enter the new **OF** value into the controller:
- Use  to increase the current value.
 - Use  to decrease the current value.
7. Press  to enter the value in the controller and display the next menu item. Continue pressing  until you exit from the hidden menu.

5.7 Replacing the Heating Cones

The heating cones are designed for long life and seldom need replacement:



However, they can occasionally malfunction. Replacement is not difficult, but, since it is not possible to remove a fan box from the chamber without breaking the entry port seal, you may need to perform the operation in the chamber. Be sure to place the fan box on the work mat and perform all activity on or over the work mat. You may wish to put protective gloves over your latex or neoprene gloves during this procedure.

► To replace the heating cones

1. Turn the unit off. Then unplug the cord from the power inlet on the side of the box:



Note: You can disconnect it from the power strip instead. However, it is usually easier to disconnect it from the box.

2. Allow the fan box to cool down.
3. Place the unit on the work mat with the heat shield facing up.
4. Using a phillips head screw driver, unscrew the 4 screws that hold the heat shield in place and put them aside:

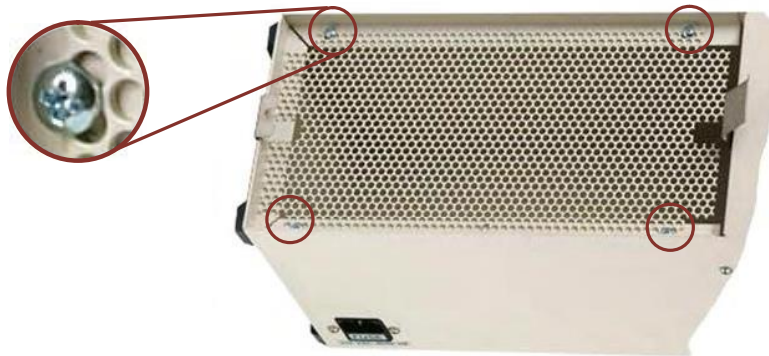

Be careful not to lose the washers!



5. Remove the heat shield and unscrew and remove the defective heating cones:



They screw and unscrew just like light bulbs.

6. Screw the replacement heating cones into their sockets:



When you are finished, your fan box should look like this:

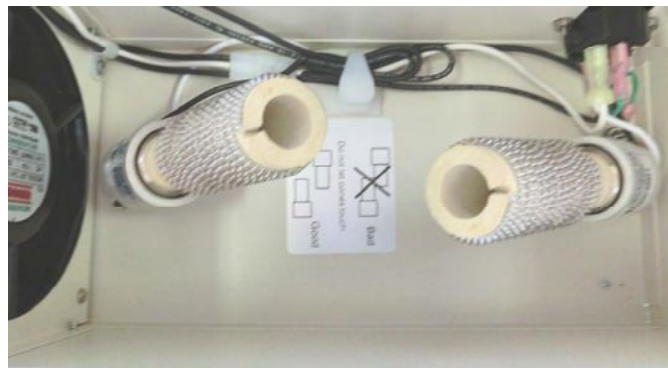

7. Reattach the heat shield with the four screws. Be sure to put the washers on:

- The washers are lock washers. They have protruding teeth on one side:

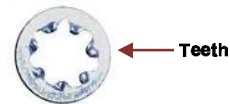

- The smooth side should be next to the underside of the screw head and the teeth toward the bottom:

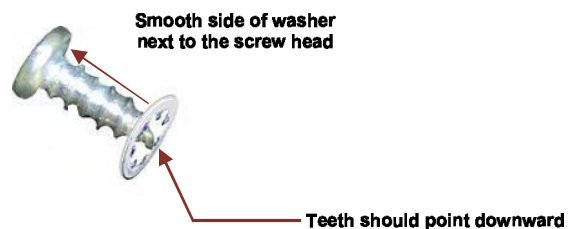

8. Reconnect the power cord and place the unit back in its location. Turn the unit on and ascertain that the new heating cones are working.



Note: If the new heating cones don't work, the problem may be in the sockets or electrical wiring. Contact Coy.

6 Controlling the Chamber Atmosphere

6

When your chamber was set up, the anaerobic environment was initially created. This environment must be maintained to an acceptable level for your chamber activities. Depending on the external environment and/or internal chamber activities, ongoing moisture control and hydrogen sulfide monitoring and control may also be necessary. This chapter contains information and/or instructions for monitoring all of the above.

Chamber temperature, when critical, is maintained automatically by heated catalyst fan boxes, which may occasionally need to be recalibrated (more information can be found in Chapter 5).

6.1 Maintaining an Anaerobic Environment

Although the airlock is cycled to anaerobic conditions before a transfer, it is still possible for small amounts of oxygen to be present and enter the airlock. Oxygen also enters the chamber by diffusion, primarily through the gloves. This amount differs, depending on the volumetric size of your chamber. The palladium catalyst removes the oxygen when the chamber atmosphere is drawn into the catalyst fan boxes. However, because removal takes place only when hydrogen molecules combine with the oxygen molecules, the hydrogen level is also depleted. If you do not have enough hydrogen present in the chamber, oxygen removal will be compromised or will stop altogether.



Note: The default oxygen level is between 0 ppm and 5 ppm. Keep in mind, however, the error reading of any digital monitor when evaluating the chamber atmosphere. For example, the Coy anaerobic monitor error rate is ± 20 ppm so a reading of 8 ppm may simply be a limitation of the monitor and not reflective of the chamber.

6.1.1 The airlock's role

When the airlock is cycled before a transfer takes place, the last cycle backfills the airlock with the hydrogen gas mix (assuming default cycles are used). When the airlock's inner door is opened, the gases from the airlock flow out of the airlock and mix with gases in the chamber, bringing more hydrogen into the chamber. Although small amounts of oxygen can also enter the chamber, the amount of oxygen is insignificant compared to the overall hydrogen content and is soon removed by the catalyst.

If the airlock is used on a regular basis, hydrogen levels are replenished periodically and the catalyst fan boxes will be able to operate efficiently for a longer period of time than if the airlock is seldom used. When the airlock is used sporadically, the hydrogen level in the chamber deteriorates faster, because it is not being replenished.

6.1.2 The catalyst's role

With enough hydrogen present in the atmosphere, the palladium catalyst can do its work. However, as the moisture generated from the oxygen and hydrogen mol-

ecules is absorbed by the alumina pellets, the palladium catalyst eventually becomes less effective, which means that oxygen removal process slows down. To maintain the anaerobic environment, the catalyst Stak-Paks must be swapped periodically (usually about once a week) with rejuvenated ones and the used ones rejuvenated. More information on catalyst rejuvenation can be found in Chapter 5 and maintenance scheduling recommendations can be found in Chapter 7.





6.1.3 Replenishing hydrogen levels

Even if you use your airlock regularly, the hydrogen levels will eventually deplete to a point where oxygen removal is compromised. So, periodically, you must introduce a new supply of hydrogen by adding gas mix. How often this needs to be done depends on how often the airlock is used and the size of the chamber (see Chapter 7 on chamber care and maintenance for more recommendations).





Note: *If you have a gas injection system (see section 6.1.4), you do not need to perform this procedure.*

► To refresh hydrogen levels

1. Make sure the outer door of the airlock is closed and locked.
2. Open the inner door of the airlock.
3. Press  to access the menu and  to enter manual mode.
4. Hold the  key down to manually vacuum the chamber.
5. When the top has collapsed to the level of the hanger poles, release :



6. Press and hold the  key to manually reinflate the chamber with gas mix.
7. When the chamber is fully inflated, release the  key.
8. Repeat steps 4 through 7 as specified below:
 - If you have an anaerobic monitor, repeat the cycle until the hydrogen level is between 1.5 % and 4 %. With a 4 % hydrogen gas mix, you should be able to achieve a level between 2.5 % and 3.5 %. Do not go above 4 %.



Note: *The Coy anaerobic monitor (CAM-12) may not work properly if the hydrogen level is less than 1.5 %.*



Note: *By default, the Coy anaerobic monitor will display an alarm light and generate an audible alarm (unless you chose to disable it) when the hydrogen level goes above 4 %. You can set the high alarm level to a value that is less than 4 % if you prefer.*

- If you do not have an anaerobic monitor, repeat the cycle as specified for your chamber size in the following table:

Chamber Type	Volume	# of Gloves	# of Repetitions
Type A	44 ft ³ (1238 L)	1 pair	3
Type B	58 ft ³ (1636 L)	2 pair	4
Type C	31 ft ³ (881 L)	1 pair	2



Note: If you have a custom chamber, select the type that is closest in size. If your chamber is significantly larger than the type B chamber, add an extra repetition.

6.1.4 Using a gas injection system

The Coy gas injection system is an optional component that allows you to maintain a constant hydrogen level in your chamber automatically:



The hydrogen gas mix is injected for a predetermined interval on a fixed schedule, which you define through the controller shown above.

The controller is set outside the chamber. A T-fitting that is attached to the gas pressure regulator allows both the gas injection system and the airlock to be connected to the gas mix tank. The tubes for gas removal and injection are pre-installed in a rubber stopper, which is inserted into the chamber through a feed-through adapter (see section 1.2.6 in Chapter 1). If the unit was ordered when your chamber was purchased, an extra feed-through adapter, located behind the airlock, will be installed at the factory. If the unit is an aftermarket purchase, you will need to use the extra feed-through adapter that was included in your chamber (or any spare feed-through adapter if you purchased extra ones with your chamber).

You will need to determine how often and how long the gas mix needs to be injected to keep the hydrogen at the desired level for your chamber. Once you set it up, the gas injection system automatically injects the gas mix into the chamber, eliminating the need to manually replenish hydrogen levels. You will still need to change Stak-Paks periodically for optimal oxygen removal. If you have a gas injection system, consult the gas injection system manual for more information.

6.2 Controlling Moisture

Moisture can enter the chamber in several ways:

- Gas supply tanks
- Ambient moisture in the airlock
- Stored media in the airlock
- Moisture producing material in the chamber

- Humidity caused by being located immediately below an air conditioning unit in a heated external environment
- Catalytic reaction during the oxygen removal process.

To remove moisture from your chamber, you may use either of the following methods:

- Alumina desiccant Stak-Paks
- Coy large capacity dehumidifier

Desiccant Stak-Paks are usually effective for minor to moderate moisture issues. For major moisture issues, the large capacity dehumidifier is the most effective choice. However, the large capacity dehumidifier must be installed in the large equipment port, making it necessary to re-create the anaerobic environment completely. Therefore, if you did not anticipate a moisture problem when you ordered your chamber, you may want to try desiccant Stak-Paks first.

6.2.1 Using desiccant Stak-Paks

Minor to moderate moisture issues may be controlled in the chamber with alumina desiccant Stak-Paks. Coy has found that moisture can be minimized with two catalyst fan boxes, using two Stak-Paks containing alumina desiccant (one in each fan box).

The desiccant Stak-Paks are attached to the catalyst Stak-Paks and both are placed in the Stak-Pak holder as a unit. Because airflow is restricted with the additional Stak-Pak, the catalyst fan box must be positioned vertically if at all possible. The vertical orientation allows the fan box to expose the maximum amount of chamber atmosphere to the desiccant, while minimizing airflow restriction.



Note: *Placing desiccant in pans throughout the chamber is not recommended, as it takes up valuable space in the chamber and the desiccant is not an active part of the circulation system. Therefore, it is extremely inefficient compared to the desiccant Stak-Paks.*

As the alumina desiccant absorbs moisture, its pores become saturated with water vapor. Therefore, they need to be rejuvenated periodically for two hours at 125 °C to 200 °C, just as the catalyst Stak-Paks do. The two attached Stak-Paks can be rejuvenated together. You do not need to disassemble them. However, your rejuvenation schedule may need to be adjusted if the desiccant Stak-Paks need rejuvenation more frequently than the catalyst Stak-Paks.



Note: *Do not use more than one desiccant Stak-Pak per catalyst fan box. More than 2 Stak-Paks dramatically reduce airflow, which affects temperature control and oxygen removal. For serious moisture control problems, we recommend using a Coy large capacity dehumidifier (see section 6.2.2) instead of trying to control moisture with multiple desiccant Stak-Paks.*

The two Stak-Paks are attached to each other with machine screws:



The screws are fastened with lock nuts. One side of the lock nut has teeth. The other is smooth:



Coy provides the necessary hardware.

► To attach a desiccant Stak-Pak to a catalyst Stak-Pak

1. Place the palladium catalyst Stak-Pak on top of the desiccant Stak-Pak as shown:

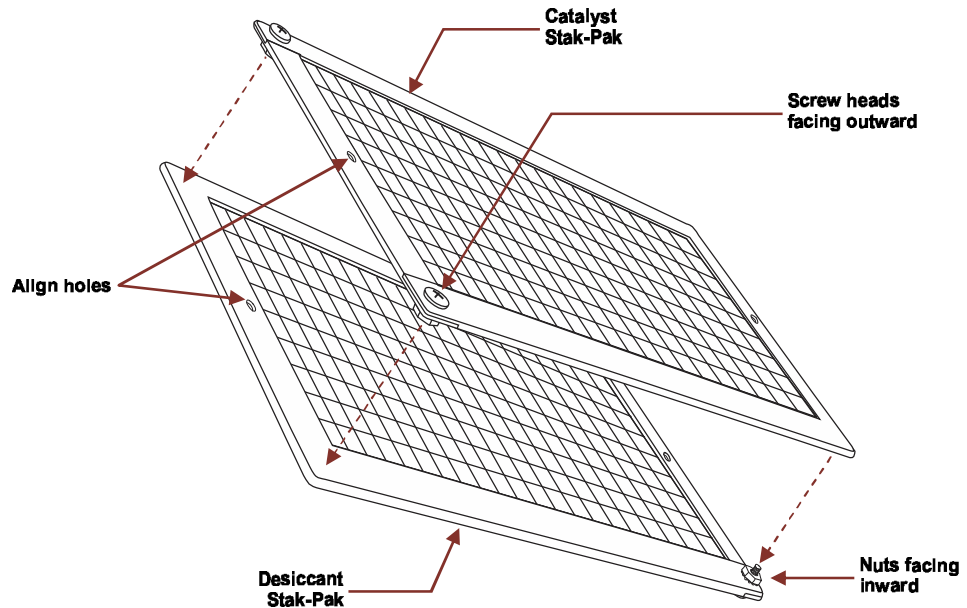

- One end of the Stak-Pak has screws. Orient the Stak-Paks so that the ends with the screws are opposite each other.
 - Make sure the sides with the screw heads are facing outward on both Stak-Paks.
 - Make sure the screw holes at the ends of the Stak-Paks are aligned.
2. Insert the provided screws through the screw holes and fasten them with the lock nuts:

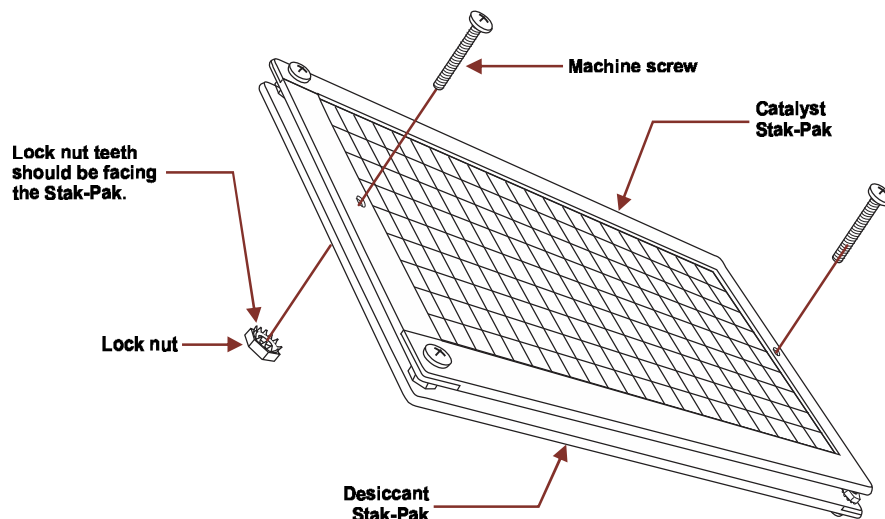

- Be sure to insert the screws through the catalyst Stak-Pak first.
- Make sure that the teeth of the lock nuts are facing inward toward the desiccant Stak-Pak.

3. When you finish, the two Stak-Paks should look like this:

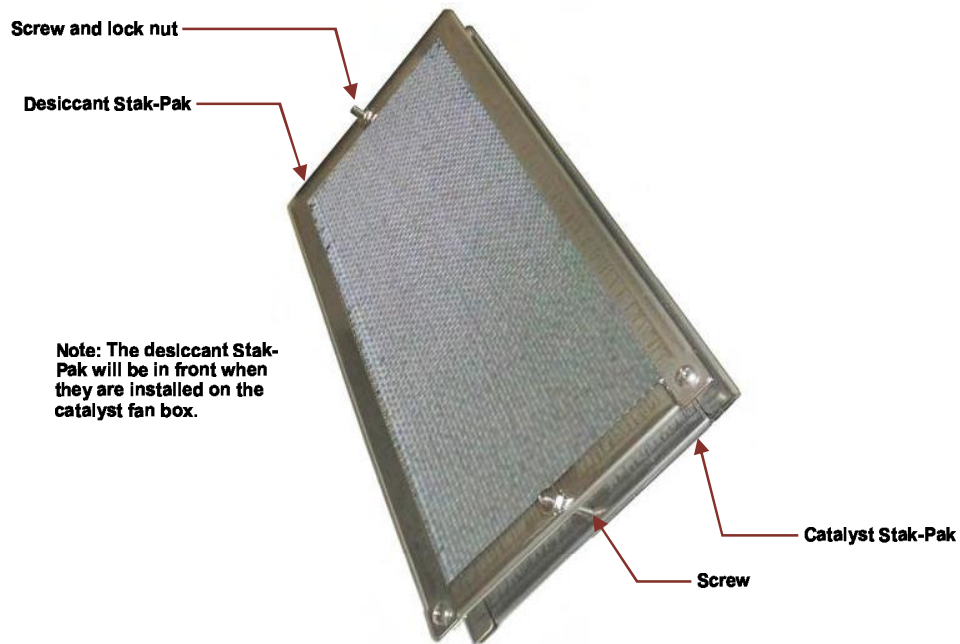

► **To place the paired Stak-Paks in the Stak-Pak holder**

1. Make sure that the catalyst Stak-Pak is in back (next to the heat shield).
2. Place the bottom of the catalyst Stak-Pak behind the hook at the bottom of the box:

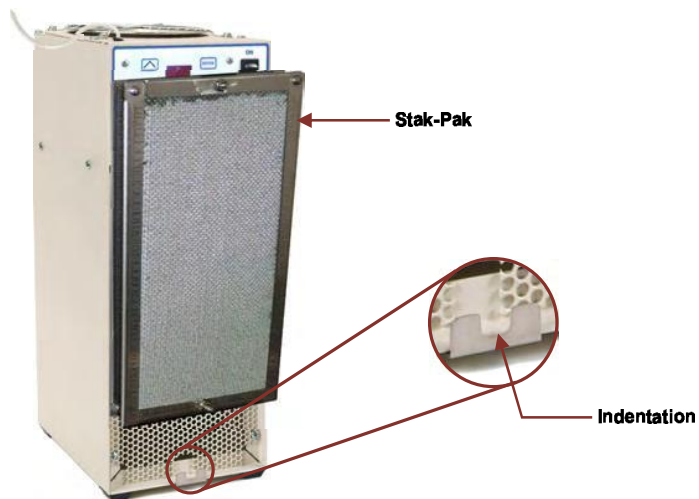

- The Stak-Pak holder hook at the bottom of the catalyst fan box should hook around the catalyst Stak-Pak.
- The screw that joins the two Stak-Paks will fit in the indentation in the middle of the hook.

3. Push the Stak-Pak into the recessed area in front of the heat shield. The clip at the top of the recessed area will clip onto the catalyst Stak-Pak only and hold the two Stak-Paks in place:



6.2.2 Using a large capacity dehumidifier

For serious moisture problems, the Coy large capacity dehumidifier is a much better option than desiccant Stak-Paks. This unit allows control of the moisture levels inside the vinyl anaerobic chamber automatically without the use of desiccant:

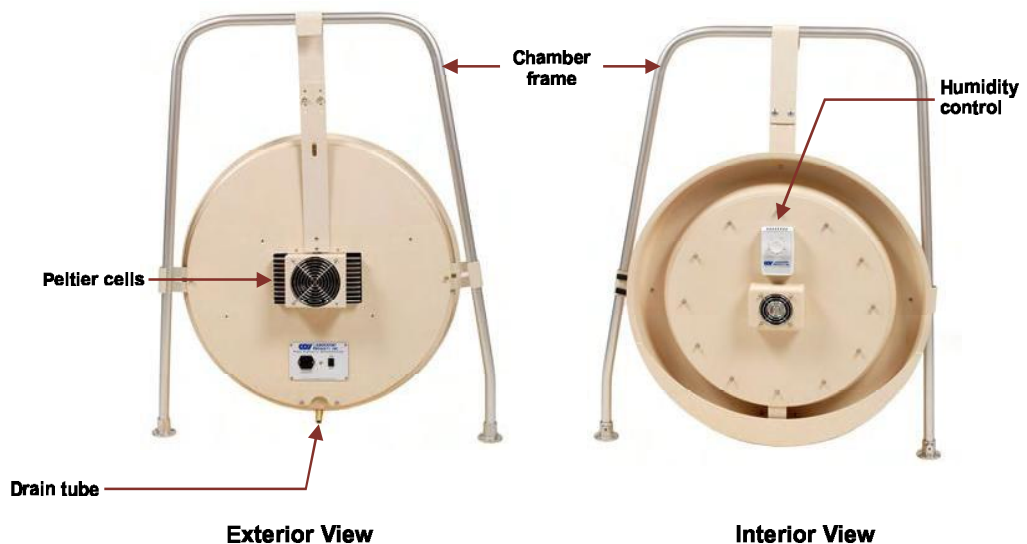

The large peltier cells create a cold wall inside the chamber to collect moisture. The collected moisture then drips into a small reservoir inside the chamber and is drained through tubing to a larger reservoir outside the chamber.

The unit attaches to the chamber frame. The dehumidifier disk is inserted into the equipment entry port in place of the original plastic disk. It is sealed to the chamber with the yellow vinyl tape:

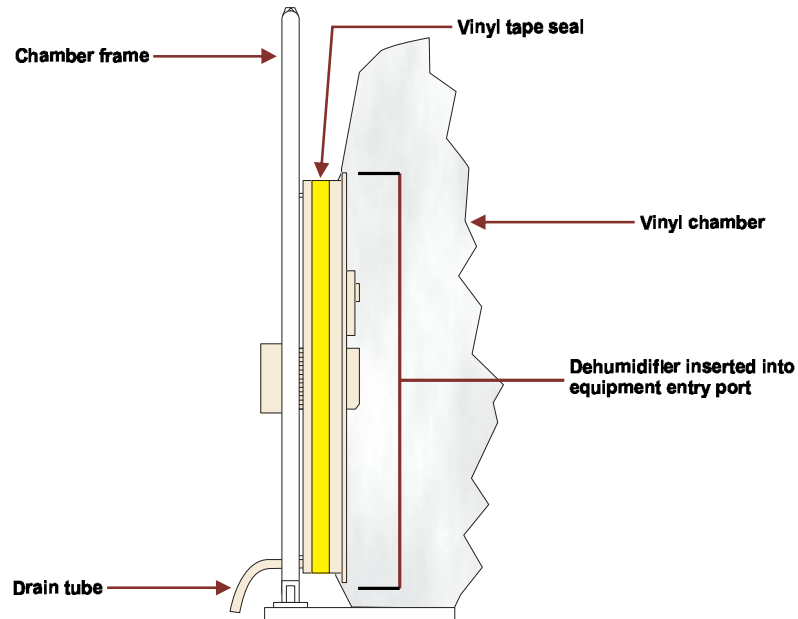

Analog controls allow you to choose an ideal level of moisture control that permits maximum humidity without condensation.

If you already have this device, you will find more information and instructions in the large capacity dehumidifier manual.

6.3 Hydrogen Sulfide Control

Some types of chamber activities may generate hydrogen sulfide (H_2S). It is important to control hydrogen sulfide in the chamber because it attacks certain metals and can damage catalyst. It also accelerates the discoloring of the vinyl over time.

Hydrogen sulfide is especially detrimental to the oxygen and hydrogen sensors in the anaerobic monitor and to printed circuit boards in incubators and heated catalyst boxes. The printed circuit boards are coated with a protective substance. However, hydrogen sulfide will attack any exposed metal and will, with time, creep under the coating and attack the metal on the boards. The time taken to affect the metal depends on the concentration of hydrogen sulfide and the humidity level.

To remove H_2S from your chamber, Coy recommends the Coy hydrogen sulfide removal column (HSRC). It has been specifically developed to provide maintenance-free, high capacity removal of H_2S and is far superior to the ad hoc chemical methods (e.g., activated charcoal, silver sulfate) used in many laboratory settings.

The HSRC stands 28 in (71.1 cm) high and can be placed either vertically on the floor of the chamber or horizontally in a cradle on a 28 in or 36 in shelf:



Vertical Orientation

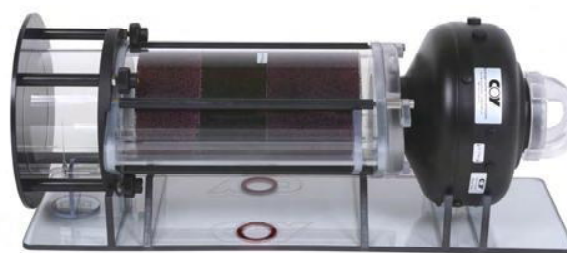

Horizontal orientation

The HSRC continuously recirculates the chamber atmosphere, drawing it into the column and returning it to the chamber. As it passes through the column, the H₂S is removed. The removal media is contained in a cartridge

The HSRC's unique layering of the media acts via a combination of adsorption and chemisorption. Having two media allows the HSRC to maintain performance under a broad range of operating conditions, since the mechanism-of-action and performance of the individual media depend on a complex set of variables. An integrated airflow system, combined with the column design, ensures required contact time and flow rate to take advantage of the high H₂S removal capacity with single-pass H₂S clearance.

The unit requires no periodic maintenance except for replacing the media, which is only needed every several months. An indicator tells you when the media needs to be replaced. Replacement is simple. The method depends on the type of cartridge you are using:

- If you are using disposable cartridges, you simply remove and discard the old cartridge and insert the new one:



- If you are using a refillable cartridge, you remove and dispose of the used media and replace it with new:



The media comes in pre-measured media packets so there is no measuring or guesswork.

If you are interested in purchasing or learning more about the HSCR, contact Coy for more information. If you have already purchased this device, refer to the product's manual for further instructions on its operation.

7 Chamber Care and Maintenance

7

To prolong the life of your chamber, special attention must be given to its care and maintenance. Daily precautions must be taken to ensure that the vinyl is kept free from damage. Periodic maintenance ensures that the chamber components are functioning optimally and problems are caught before they become major.

7.1 Precautions

The following precautions should be observed when using the chamber:

1. Do not set equipment with sharp edges on the chamber floor. Only shelving units, incubators, and work mats supplied by Coy should be placed on the chamber floor.
2. Always keep small instruments and sharp objects on the work mats. If you don't, they may get lost under the work mats and puncture the vinyl.
3. Keep equipment and shelving units within easy reach so you do not stretch the chamber sleeves.
4. Remove rings and other jewelry that could damage the vinyl or the gloves prior to using the chamber.

7.2 Preventive Maintenance Schedule

Periodic preventive maintenance is very important to ensure that the chamber is operating optimally. The following schedule details the maintenance procedures that must be done on a regular basis.

Instructions for most of the procedures can be found in this chapter. A few are located elsewhere in the manual. In either case, the appropriate section is referenced in the table. It is assumed that you are familiar with the general operation of the chamber and the airlock.

Every 5–10 days or as needed, based on chamber activity
<input checked="" type="checkbox"/> Rejuvenate the catalyst (see section 5.4.3 of Chapter 5).
<input checked="" type="checkbox"/> Refresh hydrogen levels (see section 6.1.3 of Chapter 6). Note: If you've purchased the Coy gas injection system, you may skip this step. Hint: If you have the Coy anaerobic monitor, simply refresh the hydrogen level any time the H ₂ level reads lower than 1.5 %. A tank with a 4 % gas mix should be able to achieve a 2.5 % to 3.5 % mix in the chamber.
<input checked="" type="checkbox"/> Clean the airlock seals to remove dust, dirt, and grime (see section 7.6).
<input checked="" type="checkbox"/> Clean the chamber and disinfect if necessary (see section 7.3).
<input checked="" type="checkbox"/> Check moisture trap on the vacuum pump and drain any visible water collected there (see section 7.8).

Every month

- Grease the airlock door push pins (see section 7.5).
- Check the chamber for leaks (section 7.4).
- Check both gas lines for leaks (see section 3.7 of Chapter 3). Over time, fittings on the back of the airlock or the copper tubing can become loose.
- Check the airlock seal to make sure the lip of the seal collapses all around the door opening (see section 7.6).

Every 6 months to 1 year, or as needed based on chamber activity

- Test the catalyst for effectiveness (see section 5.4.4 of Chapter 5). Replace the catalyst if you are not getting adequate temperature change.
- Check in-room air calibration of the anaerobic monitor (see the CAM-12 manual for specifics).
- Recalibrate the catalyst fan box (see Chapter 5, section 5.6).

7.3 Cleaning the Vinyl

Clean the chamber with a non-abrasive plastic cleaner and a *soft cotton cloth*. Do not use paper towels, especially Chem-Wipes, as they will scratch the vinyl.

Any commercially available cleaner recommended for polyvinyl chloride (PVC) will be sufficient for removing dust, dirt, and grease from the chamber and restoring its optical clarity. Coy Laboratory Products uses a plastic cleaner (Part No. 1600-480).



Important: Avoid cleaning the chamber with products containing ketones or other compounds that will damage PVC.

To disinfect the chamber, use isopropyl alcohol or a 1 % to 5 % chlorine bleach solution. Make sure all excess is wiped off *completely*. Alcohol or bleach that is allowed to sit on the vinyl material will weaken and yellow the vinyl over time.

7.4 Detecting Chamber Leaks

Leaks can occur anywhere in the chamber but most will be present around work areas. The gloves are the most vulnerable, as they are more likely to come into contact with tools or objects with sharp edges.

Before you check for leaks, look at the top of your chamber. If your chamber has a leak, the top of the chamber will start collapsing. If the top of your chamber has not collapsed, the chamber has no leaks and you do not need to check for leaks any further.

7.4.1 Using the gas leak detector

The Coy gas leak detector senses hydrocarbons (which are present in the hydrogen gas mix) and will detect leaks as small as a pinhole in the anaerobic chamber. It is almost a must for leak detection:



► **To operate the gas leak detector**

1. Turn the black knob clockwise as far as it will go to set the unit to the maximum setting. You will hear a high frequency beeping tone.
2. Let the gas leak detector warm up for two to five minutes on the maximum setting.
3. Turn knob counterclockwise to the minimum setting (to the point just before the unit shuts off). The beeping tone will slow down.
4. Wait until the beeping tone is about one beat per second (approximately 10 to 15 minutes). Then turn the knob clockwise until the beat pick up slightly. The unit is now ready to detect leaks.



Important: Do this adjustment in normal air conditions.



Note: If the unit does not slow down, change the battery.



Note: If the gas leak detector has not been used for an extended period of time, the warm up time maybe longer.

7.4.2 Checking the chamber for leaks

The gas leak detector detects hydrogen gas. Before you check the chamber for leaks, make sure the chamber contains your normal amount of hydrogen. If the hydrogen content is low, refresh the hydrogen level (section 6.1.3 of Chapter 6) before continuing. If you do not have an anaerobic monitor, assume the hydrogen content is low unless you have recently refreshed the hydrogen.



Hint: The gas leak detector also detects the hydrocarbons present in isopropyl alcohol fumes. An alcohol-soaked rag placed inside the chamber will enhance the hydrocarbon content and make it easier to find leaks, especially small ones. However, additional time may be required after the leak is repaired to air the chamber out to make sure the fumes from the alcohol are removed.

► **To detect leaks in the chamber**

1. Soak a rag in isopropyl alcohol and place the rag inside the chamber (optional).
2. With the inside airlock door open, inflate the chamber with gas mix until the arms are extended outward. This stretches the vinyl and makes it easier to find small leaks.
3. Turn the gas leak detector on and allow it to warm up, following the instructions in section 7.4.1.
4. Move the gas leak detector slowly over the entire chamber exterior. Pay special attention to the following:
 - Gloves and cuffs
 - Along chamber sleeves
 - Around airlock seals
 - Corners of the chamber

- Around chamber seams
- Around any taped seals

5. If you find a leak in the vinyl, follow the instructions in section 7.9.1 to repair it.



Note: You will notice a slight increase in the beeping along the interior of the sleeves and gloves. The neoprene or latex rubber in the gloves is more porous than PVC and gas diffuses through it more quickly. A true leak in this area will generate a large increase in the beeping noise. Call your local Coy representative or the factory if you are unsure.

For more accurate leak detection in this area, lower the gas leak detector sensitivity. Leaks in the gloves themselves are best found by filling them with water as described below.

► **To detect leaks in the gloves**

1. Use the vacuum pump to deflate the chamber enough so the arms are in normal working position.
2. Pour water into the gloves.
3. If water drips into the interior of the chamber, the glove has a leak.
4. If you find a leak in a glove, follow the instructions in section 7.9.2 to replace it.

7.5 Greasing the Airlock Door Handle Push Pins

Regular lubricating of the push pin on the airlock door handles helps prevent excessive wear and tear on door handle mechanism. A light silicone or lithium grease should be used.

► **To lubricate the push pins**

1. Make sure the inner airlock door is closed and locked.
2. Pull the outer door handle out and raise the door up so you can easily access the push pin:

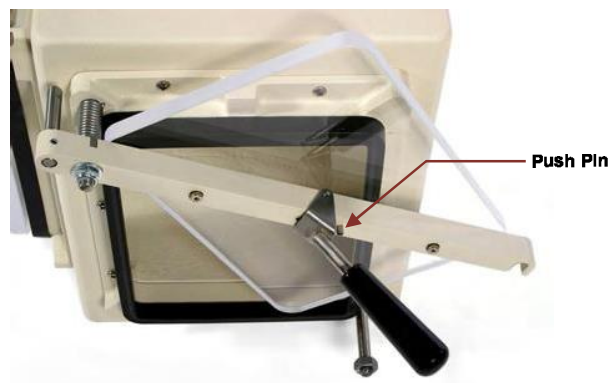

3. Lubricate the pin with the silicone or lithium grease:

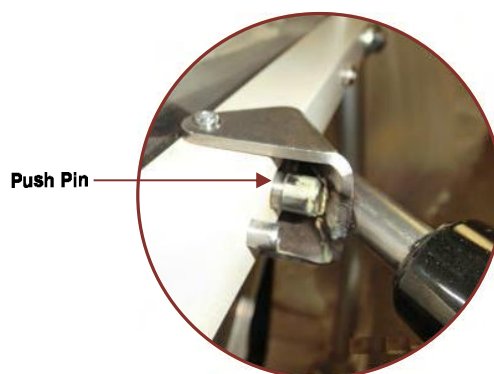

Do not overlubricate.

4. Place the lubricant you are using in the airlock. Then close and lock the outer door, but do not open the inner door.
5. Cycle the airlock to anaerobic conditions.
6. Open the inner door and follow steps 2 and 3 above to lubricate the inner door push pin.
7. Place the lubricant back in the airlock and close the inner door. Make sure it is latched and locked.
8. Remove the lubricant from the airlock through the outer door and close and lock the door.

7.6 **Cleaning the Airlock Door Seal**

The airlock doors have a black rubber seal around the door opening:

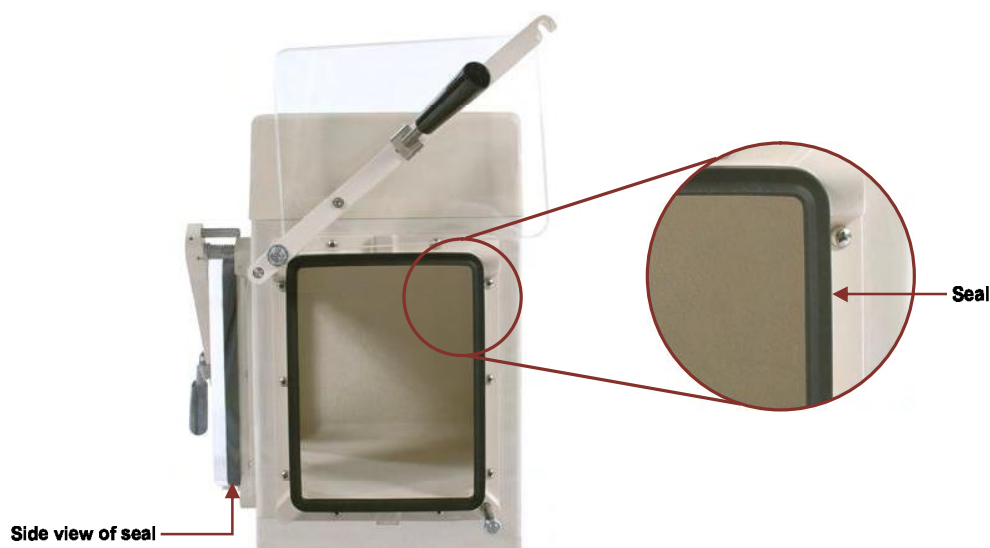

The seals must be cleaned periodically (whenever you clean your chamber) to remove dust and grime. Use water and a soft cloth to clean it. Do not use alcohol.

► **To clean the airlock door seals**

1. Close the inner door. Make sure it is latched and locked.
2. Open the outer door and clean the seal.
3. Place the cleaning materials in the airlock. Then close the outer door. Make sure it is latched and locked.
4. Cycle the airlock to anaerobic conditions.
5. Open the inner door, remove the cleaning materials, and clean the inner door seal.
6. Place the cleaning materials back in the airlock and close the inner door. Make sure it is latched and locked.
7. Remove the cleaning materials from the airlock through the outer door and close and lock the door.

7.7 **Checking the Airlock Door Seal for Leaks**

As part of your preventive maintenance, the black rubber door seals must be checked periodically (we recommend once a month) to ensure there is no leakage. You may also need to check them outside of the regular maintenance schedule if you suspect there is an airlock leak problem.

The seal has a lip around it. When the door is open, the lip looks raised, as shown below:

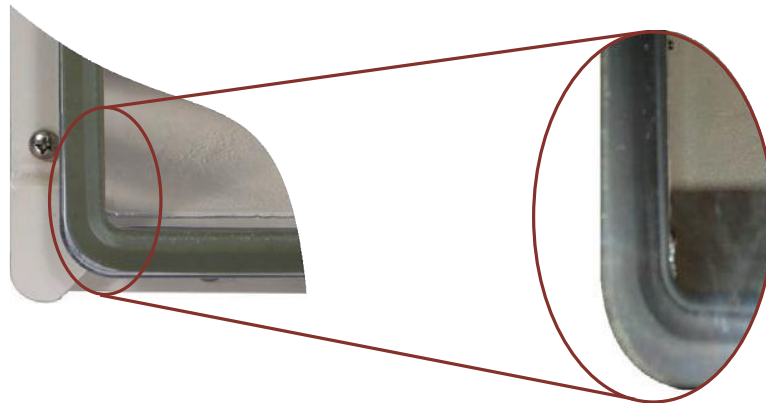

When the door is closed, the lip collapses, making an airtight seal.

► **To check the airlock door seals**

1. Make sure the inner door is latched and locked. Then open the outer door.
2. Wipe the seal with a wet cloth. Then close and lock the door.

3. Look at the seal through the acrylic door panel:

- If the lip is collapsed as shown below all the way around the door, no adjustment is needed:



- If the lip is not fully collapsed, the door will need to be adjusted. Using a crescent wrench, turn the lock nut on the lock stud (the pin at the bottom of the door opening) clockwise in very small increments until the lip collapses:



Important: $\frac{1}{16}$ of a turn is usually all it takes to tighten the door and collapse the seal. Making larger adjustments should not be necessary. If it is, the seal may need to be replaced.

4. Place the crescent wrench in the airlock and close and lock the outer door. Do not open the inner door.
5. Cycle the airlock to anaerobic conditions. Then open the inner door and remove the crescent wrench.
6. Follow steps 2 and 3 above to check the inner door seal and adjust the door if necessary.
7. Place the crescent wrench back in the airlock and close and lock the inner door.
8. Remove the crescent wrench from the airlock through the outer door.

7.8 Draining the Vacuum Pump Moisture Trap

The moisture trap on the vacuum pump may need to be drained periodically to remove the collected moisture:

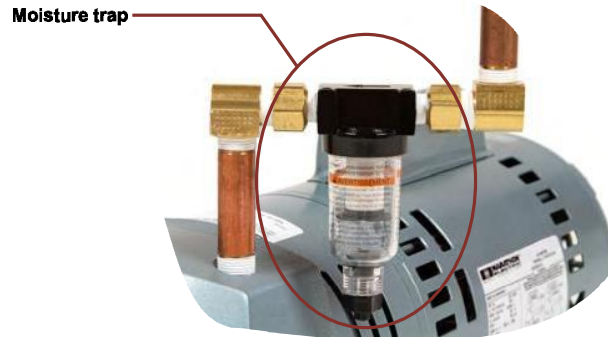

► To drain the moisture trap

1. Unscrew the plug at the bottom of the moisture trap:



2. Remove the plug and allow the moisture to drain out. Catch the liquid in a cloth or a small container if necessary.
3. Screw the plug back in.

7.9 Making Minor Repairs

While major repairs are best left to trained technical personnel, repairs to the vinyl and the gloves can easily be done by the chamber user.

7.9.1 Patching puncture and tears

Punctures and tears can be easily patched using the vinyl repair materials found in your chamber setup and care kit:



Liquid Vinyl Repair



Vinyl Material for Patching

The liquid vinyl repair softens the vinyl. When the vinyl is soft, it adheres to itself, eliminating the leak. For small leaks, you will need only the liquid vinyl repair. For large leaks, you will need both the liquid vinyl repair and the vinyl patching material and scissors to cut the patch with.

► **To patch small leaks**

1. Vacuum the chamber until the gloves sag to release the pressure.
2. Apply liquid vinyl repair directly to the hole and surrounding area.
3. Let it cure for about an hour. Then reapply liquid vinyl repair to the area.
4. Allow the second application to cure thoroughly. Then reinflate the chamber to its working level.
5. Test the patched area with the gas leak detector to make sure the leak has been properly patched.

► **To patch large leaks**

1. Vacuum the chamber until the gloves sag to release the pressure.
2. Cut a patch out of the extra vinyl supplied with the chamber setup and care kit.
3. Generously spread the liquid vinyl repair around the hole and apply the patch. You may have to hold the patch in place for 2 or 3 minutes while the liquid vinyl repair is curing.
4. In about an hour, apply the liquid vinyl repair to the edges of the patch, sealing the patch and PVC together.
5. Allow the patch to cure thoroughly. Then reinflate the chamber to its working level.
6. Test the patched area with your gas leak detector to make sure the leak has been properly patched.



Note: Since liquid vinyl repair contains hydrocarbons that will activate the leak detector, the patch must be fully cured before checking the repaired area for leaks.

7.9.2 Replacing a damaged glove

Damaged gloves may be replaced without losing the anaerobic atmosphere. Coy includes a cuff and one extra pair of gloves in the chamber setup and care kit. Additional gloves and cuffs can be ordered from Coy. It is a good idea to keep one pair of replacement gloves and cuffs for each set of glove ports in your chamber. That way you will always have an extra pair available.

To perform this repair, you will need the following from your chamber setup and care kit:



Glove



Cuff



Yellow Vinyl Tape

You will also need:

- Double-sided cellophane tape
- Scissors

► **To prepare a replacement glove**

1. Outside of the chamber prepare a new cuff by placing double-sided tape around the wide edge of the cuff:

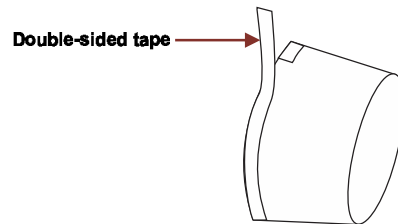

2. Place the new glove over the cuff and stretch it over the double-sided tape to hold it in place:

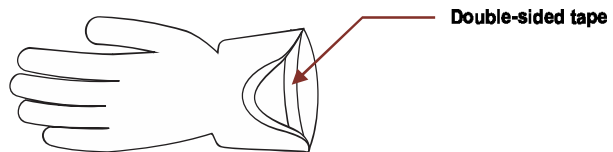

3. For optimal position when using the chamber, the seam on the chamber sleeve should line up between the thumb and index finger:

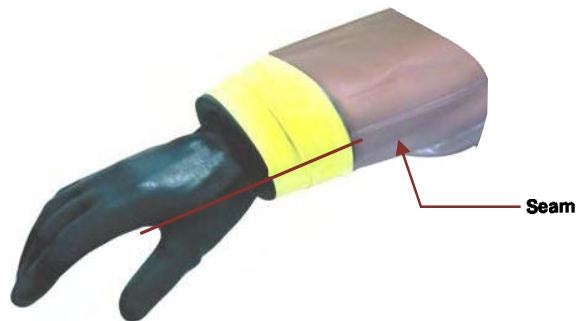

Make a mark on the cuff where the glove should line up with the seam to assist you in positioning the glove. Use crayon, chalk, tape, or anything else that won't be easily wiped off in a color that you can easily see.



Hint: You may find it easier to determine the position with your hand in the glove.

► **To change the gloves**

1. Place the yellow vinyl tape and scissors in the airlock and cycle the airlock to anaerobic conditions.
2. Place your hands in the currently installed gloves. Inside the chamber, retrieve the scissors and the roll of yellow tape from the airlock and place them within easy reach.
3. Remove the tape from the damaged glove.

4. Pull the glove through to the outside of the chamber:



5. Remove your hand from the glove, but do not remove the glove from the sleeve yet.



Important: Make sure the new glove is within easy reach!

6. Place the new glove and cuff on the correct hand. Then pull the old glove out of the sleeve with your other hand and squeeze the end of the sleeve closed with your gloved hand to prevent oxygen from entering the chamber:



Orient the glove so that the seam is between the thumb and forefinger.

7. Still grasping the end of the sleeve, push the entire sleeve into the chamber interior:



Use your free hand as needed to assist.

8. Release the end of the sleeve and quickly push the gloved hand into the sleeve opening:



Use your free hand to pull the glove up on to the cuff:



Important: *This must be done VERY QUICKLY to minimize the amount of oxygen entering the chamber!*

9. Once the glove is secured in the sleeve opening, use your free hand to pull the sleeve halfway up the cuff:



► **Taping the glove**

1. Insert your free hand into the other glove and tape the cuff to the sleeve with the yellow tape as described below:
 - Start the first revolution of tape half on the vinyl sleeve and half on the glove:



- Overlap revolutions on both sides as you go around the cuff:



2. Complete at least six revolutions to ensure that the sleeve will not slip off from the cuff. When you finish, your glove should look similar to this:



3. Cut or tear off the tape, leaving enough tape to fold down for a “dog ear” to make the next glove exchange easier:

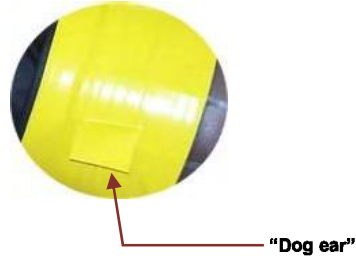

Hint: The vinyl covered by the yellow tape loses its elasticity with age, due to reaction with the glue from the tape. On some older units, it may help to trim the stiff vinyl off for a better, easier fit of the new cuff.



Important: Don't cut off more than one inch. This can be done twice to a sleeve before the opening is too large to seal around the cuff.

Parts List

Replacement Vinyl Chambers

Part #	Part	Description	Chamber Type
700040R	Anaerobic chamber, replacement	Vinyl, airlock mounted on the right	Type A
700040L	Anaerobic chamber, replacement	Vinyl, airlock mounted on the left	Type A
7050010R	Anaerobic chamber, replacement	Vinyl, airlock mounted on the right	Type B
7050010L	Anaerobic chamber, replacement	Vinyl, airlock mounted on the left	Type B
7100010R	Anaerobic chamber, replacement (size 36 in)	Vinyl, airlock mounted on the right	Type C, prior to 2006
7100010L	Anaerobic chamber, replacement (size 36 in)	Vinyl, airlock mounted on the left	Type C, prior to 2006
7100020R	Anaerobic chamber, replacement (size 42 in)	Vinyl, airlock mounted on the right	Type C, 2006 or later
7100020L	Anaerobic chamber, replacement (size 42 in)	Vinyl, airlock mounted on the left	Type C, 2006 or later

Vinyl Anaerobic Chamber Replacement Parts

Part #	Part	Description
7001005	Base, Type A	Foot print dimensions: 77 in x 36 in (1956 mm x 914 mm)
7090005	Base, Type B	Foot print dimensions: 96 in x 36 in (2438 mm x 914 mm)
7101005	Base, Type C, prior to Jan 2006	Foot print dimensions: 54 in x 36 in (1371 mm x 914 mm)
7101006	Base, Type C, Jan 2006 and later	Foot print dimensions: 60 in x 36 in (1524 mm x 914 mm)
1601430	Cuff	For glove/sleeve assembly, plastic
7000010	Equipment entry port	For vinyl chambers
6520007v	Plug strip for vinyl chambers	110 V
6520006v	Plug strip for vinyl chambers	220 V
7001002	Support frame, Type A chamber	Aluminum
7090002	Support frame, Type B chamber	Aluminum
7101002	Support frame, Type C chamber	36 in aluminum. For units purchased prior to January 2006.
7101004	Support Frame, Type C Chamber	42 in aluminum. For units purchased January 2006 and later.
1600480	Vinyl cleaner	
7005020	Vinyl repair kit	
7000060	Work mat	Plastic

General Anaerobic Chamber Consumable Parts

Catalyst Fan Boxes

Part #	Part	Description
6501050	Catalyst refill	Palladium chloride-coated alumina pellets, 180 g
6501030	Catalyst refill (1 lb)	Palladium chloride-coated alumina pellets, 453 g
6501000	Stak-Pak/w catalyst	Filled with palladium chloride-coated alumina pellets, 180 g
6502010	Desiccant refill	Alumina pellets, 180 g
6501040	Stak-Pak	Empty
6502000	Stak-Pak/w desiccant	Filled with alumina pellets, 180 g

Vinyl Chamber Gloves & Tape

Part #	Part	Description
1601426	Gloves, latex	Large cuff length, black
1601423	Gloves, latex	Medium cuff length, black
1601428	Gloves, latex	Extra large cuff length, black
1601905	Gloves, neoprene	Small
1601906	Gloves, neoprene	Medium
1601907	Gloves, neoprene	Large
1601908	Gloves, neoprene	X Large
1600321	Tape, double-sided (transfer)	For securing glove to plastic cuff during glove replacement
1600323	Tape, filament	
1600320	Tape, yellow vinyl	For taping glove/cuff assembly to chamber sleeve

General Anaerobic Chamber Replacement Parts

Part #	Part	Description
8535029	Catalyst box, heated	High range (to 50 °C), 110 V
8535030	Catalyst box, heated	High range (to 50 °C), 220 V
8535025	Catalyst box, heated	Low range (to 40 °C), 110 V
8535026	Catalyst box, heated	Low range (to 40 °C), 220 V
8535027	Catalyst box, unheated	110 V
8535028	Catalyst box, unheated	220 V
7002050	Moisture trap assembly	For vacuum pump

Vacuum Airlock and Gas Regulators

Part #	Part	Description
6300000	Vacuum airlock	Automatic, 110 V, with pump
6300220	Vacuum airlock	Automatic, 220 V, with pump
6300010	Vacuum airlock	Automatic, 110 V, without pump

Part #	Part	Description
6300230	Vacuum airlock	Automatic, 220 V, without pump
6301120	Airlock, electronic upgrade kit	110 V or 220 V
7003000	Gas regulator	Gas mix, with copper tubing
7004000	Gas regulator	Background gas (N ₂), with copper tubing
7002020	Tube, vacuum	5/8 in ID, for pump to airlock connection
7002000	Vacuum pump	110 V. For automatic airlock
7002220	Vacuum pump	220 V. For automatic airlock
1601230	Copper tubing	For gas regulators

Fan Box Replacement Parts

Part #	Part	Description
2600135	Fan	110 V
2600140	Fan	220 V
2600040	Heating cone	110 V
2600050	Heating cone	220 V
2200175	Sensor	Catalyst box temperature assembly
4300162	Fuse	GDC 4 A (5 mm x 20 mm)